

www.cofan.es



10^a EDICIÓN

CATÁLOGO TORNILLERÍA / CATALOGUE VISSERIE

FASTENERS CATALOGUE / CATALOGO VITERIA / CATÁLOGO ELEMENTOS DE FIXAÇÃO



ÍNDICE / INDEX / CONTENTS

INDICE / ÍNDICE

TORNILLO HEXAGONAL VIS À MÉTAUX TÊTE HEXAGONALE HEXAGON SCREW VITI TESTA ESAGONALE PARAFUSO HEXAGONAL



DIN 931 BAJA RESISTENCIA
0018 + Size

ZINCADO
ZINGUÉ
ZINC PLATED
ZINCATO
ZINCADO



6

DIN 931 10.9
0015 + Size + N

NEGRO
NOIR
BLACK
NERO
PRETO



11

DIN 933 BAJA RESISTENCIA
0008 + Size

ZINCADO
ZINGUÉ
ZINC PLATED
ZINCATO
ZINCADO



6

DIN 933 10.9
0005 + Size + N

NEGRO
NOIR
BLACK
NERO
PRETO



11

DIN 931/934 BAJA RESISTENCIA
0017 + Size

ZINCADO
ZINGUÉ
ZINC PLATED
ZINCATO
ZINCADO



7

DIN 933 12.9
0009 + Size

NEGRO
NOIR
BLACK
NERO
PRETO



12

DIN 933/934 BAJA RESISTENCIA
0007 + Size

ZINCADO
ZINGUÉ
ZINC PLATED
ZINCATO
ZINCADO



7

DIN 931 8.8
0013 + Size

NEGRO
NOIR
BLACK
NERO
PRETO



12

DIN 931 8.8
0011 + Size + Z

ZINCADO
ZINGUÉ
ZINC PLATED
ZINCATO
ZINCADO



8

DIN 933 8.8
0003 + Size

NEGRO
NOIR
BLACK
NERO
PRETO



8

DIN 933 8.8
0001 + Size + Z

ZINCADO
ZINGUÉ
ZINC PLATED
ZINCATO
ZINCADO



8

DIN 931 8.8
0012 + Size

ZINCADO
ZINGUÉ
ZINC PLATED
ZINCATO
ZINCADO



8

DIN 931 8.8
0011 + Size + N

NEGRO
NOIR
BLACK
NERO
PRETO



9

DIN 933 8.8
0002 + Size

NEGRO
NOIR
BLACK
NERO
PRETO



9

DIN 933 8.8
0001 + Size + N

NEGRO
NOIR
BLACK
NERO
PRETO



9

DIN 960 8.8
0006 + Size

NEGRO
NOIR
BLACK
NERO
PRETO



9

DIN 931 10.9
0015 + Size + Z

ZINCADO
ZINGUÉ
ZINC PLATED
ZINCATO
ZINCADO



10

DIN 961 8.8
0016 + Size

NEGRO
NOIR
BLACK
NERO
PRETO



10

DIN 933 10.9
0005 + Size + Z

ZINCADO
ZINGUÉ
ZINC PLATED
ZINCATO
ZINCADO



10

DIN 6921 8.8
6921 + Size

ZINCADO
ZINGUÉ
ZINC PLATED
ZINCATO
ZINCADO



10

TORNILLO ALLEN VIS À MÉTAUX TÊTE ALLEN ALLEN SCREW VITI TESTA ALLEN PARAFUSO ALLEN



DIN 912 8.8
0022 + Size + Z

ZINCADO
ZINGUÉ
ZINC PLATED
ZINCATO
ZINCADO



16

DIN 912 8.8
0022 + Size + N

NEGRO
NOIR
BLACK
NERO
PRETO



16

DIN 912 12.9
0024 + Size

NEGRO
NOIR
BLACK
NERO
PRETO



17

DIN 7380 10.9
7380 + Size + Z

ZINCADO
ZINGUÉ
ZINC PLATED
ZINCATO
ZINCADO



17

DIN 7991 10.9
7991 + Size + Z

ZINCADO
ZINGUÉ
ZINC PLATED
ZINCATO
ZINCADO



18

DIN 7991 10.9
7991 + Size

NEGRO
NOIR
BLACK
NERO
PRETO



18

VARIOS TORNILLERÍA DIVERS VISSERIE OTHER FASTENERS VARIE VITERIA VÁRIOS FIXADORES



DIN 603 BAJA RESISTENCIA
0087 + Size

ZINCADO
ZINGUÉ
ZINC PLATED
ZINCATO
ZINCADO



19

DIN 603+934 BAJA RESISTENCIA
0081 + Size + Z

ZINCADO
ZINGUÉ
ZINC PLATED
ZINCATO
ZINCADO



19

DIN 608/934 8.8
0080 + Size + B

BICROMATADO
BICHROMATÉ
BICHROMATED
BICROMATO
BICROMATADO



20

DIN 608/934 BAJA RESISTENCIA
0085 + Size + P

PULIDO
POLIE
POLISHED
LUCIDATO
POLIDO



20



DIN 604/934 6.8
0088 + Size + P

PULIDO
POLIE
POLISHED
LUCIDATO
POLIDO



21

DIN 604/934 8.8
0089 + Size



21

DIN 608/934 8.8
0080 + Size + N

NEGRO
NOIR
BLACK
NERO
PRETO



22

8.8
0091 + Size + Z

ZINCADO
ZINGUÉ
ZINC PLATED
ZINCATO
ZINCADO

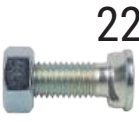

22

12.9/934 - 10
0092 + Size



23

8.8 - 8 - 934
0093 + Size



23

8.8 - 8 - 934
0094 + Size



23

DIN 127

0057 + Size + P



45

0089 + Size
0088 + Size 8.8
NEGRO
NOIR
BLACK
NERO
PRETO



46

VARILLAS
TIGES FILETÉES
THREADED RODS
VITI SENZA TESTA
HASTES



DIN 975 BAJA RESISTENCIA
0040 + Size + Z

ZINCADO
ZINGUÉ
ZINC PLATED
ZINCATO
ZINCADO



24

DIN 975 BAJA RESISTENCIA // 2 m
0040 + Size + Z

ZINCADO
ZINGUÉ
ZINC PLATED
ZINCATO
ZINCADO

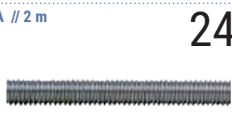

24

DIN 975 8.8

0067 + Size 0067 + Size + Z
NEGRO ZINCADO
NOIR ZINGUÉ
BLACK ZINC PLATED
NERO ZINCATO
PRETO ZINCADO



25

DIN 975 LOW RESISTANCE

0040 + Size + Z 0040 + Size + I
ZINCADO ZINCADO
ZINGUÉ IZQUIERDAS
ZINC PLATED A GAUCHE
ZINCATO LEFT HAND
ZINCADO SINISTRO
ZINCADO ESQUERDAS



26

DIN 913 45H
0083 + Size

NEGRO
NOIR
BLACK
NERO
PRETO



27 - 28

DIN 914 45H
0084 + Size

NEGRO
NOIR
BLACK
NERO
PRETO



29

0047 + Size
ZINCADO
ZINGUÉ
ZINC PLATED
ZINCATO
ZINCADO



37

DIN 6334 0048 + Size

ZINCADO
ZINGUÉ
ZINC PLATED
ZINCATO
ZINCADO



37

ROSCAMETAL
FILETAGE METAL
METAL THREAD
VITI PER MATA LLO
ROSCA METAL



DIN 84 0060 + Size

ZINCADO
ZINGUÉ
ZINC PLATED
ZINCATO
ZINCADO



50

DIN 85 0063 + Size

ZINCADO
ZINGUÉ
ZINC PLATED
ZINCATO
ZINCADO



50

DIN 7985 0064 + Size

ZINCADO
ZINGUÉ
ZINC PLATED
ZINCATO
ZINCADO



51

DIN 963 0061 + Size

ZINCADO
ZINGUÉ
ZINC PLATED
ZINCATO
ZINCADO



51

DIN 965 0065 + Size

ZINCADO
ZINGUÉ
ZINC PLATED
ZINCATO
ZINCADO



52

DIN 966 0068 + Size

ZINCADO
ZINGUÉ
ZINC PLATED
ZINCATO
ZINCADO



52

1800 43 + Size

ZINCADO
ZINGUÉ
ZINC PLATED
ZINCATO
ZINCADO



58

1800 44 + Size

ZINCADO
ZINGUÉ
ZINC PLATED
ZINCATO
ZINCADO



58

AUTOTALADRANTE
VIS AUTOPERCEUSES
SELF-DRILLING SCREW
VITI AUTOPERFORANTI
AUTOPERFORANTE



0208 + Size

ZINCADO
ZINGUÉ
ZINC PLATED
ZINCATO
ZINCADO



46

0208 + Size + N

LACADO
LAQUE
VARNISHED
VERNICIARE
LACADO



46

0208 + Size + B

LACADO
LAQUE
VARNISHED
VERNICIARE
LACADO



46

0208 + Size + I

INOX A-2
INOX A-2
A-2 STAINLESS STEEL
INOX A-2
INOX A-2



46

DIN 7504K EPDM
0205 + Size

ZINCADO
ZINGUÉ
ZINC PLATED
ZINCATO
ZINCADO



47

0205 + Size
SANDWICH
SANDWICH
SANDWICH
SANDWICH
SANDWICH

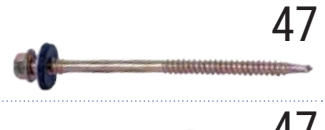

47

0206 + Size
ZINCADO
ZINGUÉ
ZINC PLATED
ZINCATO
ZINCADO



47

DIN 7504K EPDM
0204 + Size

ZINCADO
ZINGUÉ
ZINC PLATED
ZINCATO
ZINCADO



48

0207 + Size + L
ARANDELA EPDM
RONDELLES EPDM
EPDM WASHERS
RONDELLE EPDM
ARRUELA EPDM



48

DIN 7504N EPDM
0202 + Size

ZINCADO
ZINGUÉ
ZINC PLATED
ZINCATO
ZINCADO



49

DIN 7504P EPDM
0203 + Size

ZINCADO
ZINGUÉ
ZINC PLATED
ZINCATO
ZINCADO



49

ROSCACHAPA
VIS À TÔLE
SELF TAPPING SCREW
VITI AUTOFILETTANTI
AUTORROSCANTE



DIN 571 0126 + Size

ZINCADO
ZINGUÉ
ZINC PLATED
ZINCATO
ZINCADO



53

DIN 6928 0209 + Size

ZINCADO
ZINGUÉ
ZINC PLATED
ZINCATO
ZINCADO



53

DIN 7981 0111 + Size

ZINCADO
ZINGUÉ
ZINC PLATED
ZINCATO
ZINCADO



54

DIN 7982 0113 + Size

ZINCADO
ZINGUÉ
ZINC PLATED
ZINCATO
ZINCADO



54

DIN 7983 0114 + Size

ZINCADO
ZINGUÉ
ZINC PLATED
ZINCATO
ZINCADO



54

PANELES DE YESO
PANNEAUX DE PLÂTRE
PLASTER PANEL
PANNELI IN GESSO
PAINES DE GESSO



0109 + Size

FOSFATADO
PHOSPHATE
PHOSPHATIZED
FOSFATO
FOSFATO



55

0110 + Size

FOSFATADO
PHOSPHATE
PHOSPHATIZED
FOSFATO
FOSFATO



55



ÍNDICE / INDEX / CONTENTS

INDICE / ÍNDICE

ROSCAMADERA FLETAGE BOIS WOOD THREAD VITI PER LEGNO ROSCA MADEIRA

DIN 7505A

0251 + Size



TORX
TORX
TORX
TORX



56

DIN 7505A

0250 + Size

POZIDRIVE
POZIDRIVE
POZIDRIVE
POZIDRIVE
POZIDRIVE



57

0105 0 + Size + N

0105 0 + Size + Z

NEGRO
NOIR
BLACK
NERO
PRETO

ZINCADO
ZINGUÉ
ZINC PLATED
ZINCATO
ZINCADO



57

0105 1 + Size

TIRADOR
TIRAGE
FURNITURE HANDLE
MANIGLIE CASSETTI
MONTAGEM



58

TIRAFONDOS TIRE-FONDS WOOD SCREW VITI PER LEGNO IN FERRO PARAFUSOS



DIN 571

0126 + Size

ZINCADO
ZINGUÉ
ZINC PLATED
ZINCATO
ZINCADO



53

0252 + Size

ZINCADO
ZINGUÉ
ZINC PLATED
ZINCATO
ZINCADO



60

0255 + Size

ZINCADO
ZINGUÉ
ZINC PLATED
ZINCATO
ZINCADO



60

TUERCAS ECROUS NUTS DADI PORCA



DIN 934 8

0032 + Size

ZINCADO
ZINGUÉ
ZINC PLATED
ZINCATO
ZINCADO

0032 + Size + N

NEGRO
NOIR
BLACK
NERO
PRETO



30

DIN 934 8-10

0032 + Size

NEGRO - PASO FINO
NOIR - PAS FIN
BLACK - FINE PITCH
NERO - PASSO FINE
PRETO - PASSO FINO

0035 + Size + N

NEGRO
NOIR
BLACK
NERO
PRETO



31

DIN 934 BAJA RESISTENCIA

0046 + Size

NEGRO
NOIR
BLACK
NERO
PRETO

WHITWORTH - UNC

32



DIN 934 8

0038 + Size

NEGRO
NOIR
BLACK
NERO
PRETO

WHITWORTH - UNC

32



DIN 934 8

0038 + Size + I

PULIDO + IZQUIERDAS
POLIE + A GAUCHE
POLISHED + LEFT HAND
LUCIDATO + SINISTRO
POLIDO + ESQUERDAS

WHITWORTH - UNC

33



DIN 934 8

0039 + Size

NEGRO
NOIR
BLACK
NERO
PRETO

UNF - UNS (SAE)

33



DIN 985

8 0037 + Size

ZINCADO
ZINGUÉ
ZINC PLATED
ZINCATO
ZINCADO

10 0049 + Size

ZINCADO
ZINGUÉ
ZINC PLATED
ZINCATO
ZINCADO

WHITWORTH - UNC

34



DIN 985 8

0041 + Size

ZINCADO
ZINGUÉ
ZINC PLATED
ZINCATO
ZINCADO

WHITWORTH - UNC

35



DIN 985 8

0045 + Size

ZINCADO
ZINGUÉ
ZINC PLATED
ZINCATO
ZINCADO

UNF - UNS (SAE)

35



DIN 1587

0033 + Size

ZINCADO
ZINGUÉ
ZINC PLATED
ZINCATO
ZINCADO

WHITWORTH - UNC

36



DIN 315

0034 + Size

ZINCADO
ZINGUÉ
ZINC PLATED
ZINCATO
ZINCADO

WHITWORTH - UNC

36



DIN 935 8

0066 + Size

ZINCADO
ZINGUÉ
ZINC PLATED
ZINCATO
ZINCADO

WHITWORTH - UNC

36



DIN 936

0058 + Size + Z

ZINCADO
ZINGUÉ
ZINC PLATED
ZINCATO
ZINCADO

36



DIN 6330

0069 + Size

ZINCADO
ZINGUÉ
ZINC PLATED
ZINCATO
ZINCADO

37



DIN 6923 8

0062 + Size

ZINCADO
ZINGUÉ
ZINC PLATED
ZINCATO
ZINCADO

38



DIN 6926 8

0070 + Size

ZINCADO
ZINGUÉ
ZINC PLATED
ZINCATO
ZINCADO

39



ARANDELAS RONDELLES WASHERS RONDELLE ARRUELAS



DIN 125

0052 + Size

ZINCADO
ZINGUÉ
ZINC PLATED
ZINCATO
ZINCADO

40



DIN 9021

0053 + Size

ZINCADO
ZINGUÉ
ZINC PLATED
ZINCATO
ZINCADO

40



DIN 127

0057 + Size

ZINCADO
ZINGUÉ
ZINC PLATED
ZINCATO
ZINCADO

41



0054 + Size
CÓNICA ESTRIADA
RONDELLES CONTACT
CONTACTLOCK WASHER
CONICHE ZIGRINATE
CÓNICAS ESTRIADAS

41



DIN 6797-A

0075 + Size

DENTADA
DENTÉE
TOOTHED
DENTATA
DENTADA

41



DIN 6797-J

0076 + Size

DENTADA
DENTÉE
TOOTHED
DENTATA
DENTADA

41



DIN 6798

0051 + Size

DENTADA
DENTÉE
TOOTHED
DENTATA
DENTADA

42





DIN 463 0073 + Size

DOS SOLAPAS
DEUX RABATS
TWO TAB
ANGULO RETO
DOIS ORELHAS

42



DIN 434

0074 + Size + P 0074 + Size + Z
PULIDO ZINCADO
POLIE ZINGUÉ
POLISHED ZINC PLATED
LUCIDATO ZINCATO
POLIDO ZINCADO

42

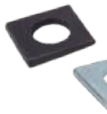

0059 + Size
COBRE CARTER
CUIVRE CARTER
COPPER CARTER
RAME CARTER
COBRE CARTER

43



0055 + Size 0056 + Size
COBRE ALUMINIO
CUIVRE ALUMINIUM
COPPER ALUMINIUM
RAME ALLUMINIO
COBRE ALUMÍNIO

43 - 44



0079 + Size
METAL GOMA
MÉTAL CAOUTCHOUC
METAL RUBBER
METALLO GOMMA
METAL BORRACHA

45



**HEMBRILLAS
CROCHET DE FIXATION
HOOKS OF FIXATION
GANCI
PARAFUSOS**

0106 + Size
ALCAYATA ROSCA
CROCHETS DE FIXATION
HOOK OF FIXATION
GANCIO A RAMPINO
ESCÁPULA COM ROSCA

59



0108 + Size
HEMBRILLA ABIERTA
CROCHET DE FIXATION
OPENED HOOK
GANCIO A VITE
PARAFUSOS COM OLHAL ABERTO

59



0107 + Size
HEMBRILLA CERRADA
CROCHET DE FIXATION
CLOSED HOOK
OCCHIELLO A VITE
PARAFUSOS COM OLHAL FECHADO

59



**PUNTAS
POINTES
TIP
PUNTE
PONTAS**

0120 + Size
0121 + Size
0122 + Size
0123 + Size

61



**LATÓN
LAITON
BRASS
OTTONE
LATÃO**

DIN 934 0032 + Size

DIN 1587 0033 + Size

62



DIN 125 0052 + Size

DIN 975 0040 + Size

62



**INOX A-2
INOX A-2
A-2 STAINLESS STEEL
INOX A-2
INOX A-2**

DIN 931 0026 + Size

64



INOX

DIN 933 0025 + Size

65



INOX

DIN 912 0023 + Size

INOX

DIN 7991 7991 + Size + I

INOX

DIN 7380 7380 + Size + I

INOX

DIN 603 0087 + Size + I

INOX

DIN 934 0028 + Size

DIN 985 0029 + Size

INOX

DIN 315 0043 + Size

INOX

DIN 1587 0044 + Size

INOX

DIN 125 0027 + Size

DIN 9021 0030 + Size

DIN 127 0031 + Size

INOX

0106 + Size

INOX

0108 + Size

INOX

0107 + Size

INOX

DIN 975 0042 + Size

INOX

DIN 84 0060 + Size + I

INOX

DIN 7985 0064 + Size + I

INOX

DIN 963 0061 + Size + I

INOX

DIN 965 0065 + Size + I

INOX

DIN 7981 0111 + Size + I

INOX

DIN 7982 0113 + Size + I

INOX

DIN 7505A 0250 + Size + I

INOX

DIN 571 0126 + Size + I

INOX

66



67



68



68



69



69



69



70



71



71



71



71



71



72



72



73



73



74



74



75



75



DIN	Páginas
DIN 84	50-72
DIN 85	50
DIN 125	40-62-70
DIN 127	41-45-70
DIN 315	36-69
DIN 434	42
DIN 463	42
DIN 571	53-75
DIN 603	19-68
DIN 603/934	19
DIN 604/934	21
DIN 608/934	20-22
DIN 912	16-17-66
DIN 913	27-28
DIN 914	29
DIN 931	6-8-9-10-11-12-13-14-64
DIN 931/934	7
DIN 933	6-8-9-10-11-12-13-14-65
DIN 933/934	7
DIN 934	30-31-32-33-62-69
DIN 935	36
DIN 936	36
DIN 960	15
DIN 961	15
DIN 963	51-73
DIN 965	52-73
DIN 966	52
DIN 975	24-25-26-62-71
DIN 985	34-35-69
DIN 1587	36-62-69
DIN 6330	37
DIN 6334	37
DIN 6797-A	41
DIN 6797-J	41
DIN 6798	42
DIN 6921	38
DIN 6923	38
DIN 6928	53
DIN 7380	17-68
DIN 7504K	47-48
DIN 7504N	49
DIN 7504P	49
DIN 7505A	56-57-75
DIN 7981	54-74
DIN 7982	54-74
DIN 7983	54
DIN 7985	51-72
DIN 7991	18-67
DIN 9021	40-70
DIN 6926	39

TORNILLO HEXAGONAL ROSCA PARCIAL ZINCADO / VIS À MÉTAUX TÊTE HEXAGONALE FILETAGE PARTIEL ZINGUÉ
HEXAGON HEAD BOLT PARTIAL THREAD ZINC PLATED / VITI ACCIAIO TESTA ESAGONALE GAMBO PARZIALMENTE FILETTATO ZINCATO
PARAFUSO HEXAGONAL ROSCA PARCIAL ZINCADO

Ref. 0018

+ Medida / Dimensions / Size / Dimensioni / Medida

DIN 931



**BAJA RESISTENCIA
LOW RESISTANCE**



	M	M-5	M-6	M-8	M-10	M-12	M-14	M-16	M-18	M-20	M-22	M-24
		80	100	125	150	175	200	200	250	250	250	300
30			8,05									
35		10,84	8,55	15,65								
40		11,40	8,82	19,45	25,91							
45		12,60	9,30	22,65	33,67	48,60						
50		13,66	10,10	25,35	37,35	52,65	80,10					
60		18,50	11,33	27,10	40,20	61,50	85,25	105,10	147,84			
65			13,92	30,55	45,50	66,35	89,90	129,60	151,07	234,70		
70			15,74	33,25	47,25	70,00	93,50	135,25	168,20	247,63	312,31	377,92
80		30,25	19,05	35,40	48,65	75,10	102,55	141,65	178,10	273,04	345,58	435,67
90	Price x 100 units		20,41	37,55	49,31	77,60	110,65	145,10	194,50	298,91	378,85	465,10
100			21,75	41,33	71,65	92,30	135,90	161,20	242,80	324,79	411,18	515,59
110				43,85	76,25	95,50	142,00	169,90	248,95	350,20	443,52	555,79
120				46,50	79,85	99,45	149,20	178,10	260,00	376,07	477,71	594,59
130				51,90	81,75	110,53	155,60	201,00	310,14	401,02	499,88	622,31
140				57,65	86,25	121,85	160,03	205,00	315,75	426,43	533,61	661,12
150				63,75	98,29	127,95	188,51	220,40	335,55	452,30	566,76	699,93
160					108,19	134,96	205,87	230,55	381,61	478,17	600,14	773,09
170						145,55	215,25	250,45	400,40	500,50	629,20	836,42
180						130,10	165,40	230,85	285,65	424,58	529,45	666,67
200					168,19	184,31	240,53	310,25	462,92	583,04	733,66	894,43
≤ 60		200	200	200	100	100	50	50	50			
65 - 100		200	100	100	100	50	50	25	25	25	15	10
110 - 140				50	50	25	25	25	10	10	10	5
≥ 150				50	25	10	10	10	10	5	5	5

TORNILLO HEXAGONAL ROSCA ENTERA ZINCADO / VIS À MÉTAUX TÊTE HEXAGONALE ENTIÈREMENT FILETÉE ZINGUÉ
HEXAGON CAP SCREW FULL THREAD ZINC PLATED / VITI ACCIAIO TESTA ESAGONALE GAMBO INTERAMENTE FILETTATO ZINCATO
PARAFUSO HEXAGONAL ROSCA TOTAL ZINCADO

Ref. 0008

+ Medida / Dimensions / Size / Dimensioni / Medida

DIN 933



**BAJA RESISTENCIA
LOW RESISTANCE**



	M	M-4	M-5	M-6	M-8	M-10	M-12	M-14	M-16	M-18	M-20	M-22	M-24
		70	80	100	125	150	175	200	200	250	250	250	300
10		5,43	6,64	4,16									
12		5,60	6,70	4,50	8,63								
16		5,80	6,80	4,60	9,10	18,40	22,10						
20		5,90	6,90	5,06	10,14	19,35	27,43	57,65					
25		6,05	7,01	6,08	11,15	20,73	30,55	58,85	63,50				
30		6,19	7,69	6,52	12,21	21,55	31,20	59,50	68,00	112,15	164,10		
35		7,49	8,62	7,57	14,58	24,78	34,20	60,10	72,85	129,99	165,10		
40		7,88	9,56	8,35	15,40	27,04	36,45	62,00	80,35	135,60	166,20	219,91	
45	Price x 100 units	11,13	11,10	9,45	17,91	29,80	44,05	65,65	82,60	140,50	167,30	226,55	
50		11,45	11,43	10,00	18,55	32,11	44,80	67,10	83,30	160,25	168,50	236,60	263,18
60			18,31	11,56	19,89	35,88	52,91	77,15	95,45	165,80	170,55	243,94	278,59
65				12,10	26,37	38,24	53,85	82,30	105,20	168,35	178,79	366,96	334,44
70				13,35	26,60	39,15	55,00	88,96	110,52	170,25	187,57	370,15	344,55
80				14,95	30,15	45,10	63,27	90,10	118,05	175,65	205,59	376,90	353,85
90				15,50	30,88	51,88	75,60	101,25	128,45	198,25	237,89	384,55	360,36
100				16,35	33,60	52,50	78,20	102,35	137,45	200,63	262,74	380,50	387,62
110					34,10	54,60	83,50	105,45	160,05	236,38	338,65	390,60	453,57
120						60,91	87,17	132,00	180,25	273,90	361,28	410,25	478,12
≤ 35		200	200	200	200	100	100	50	50	50	25		
40 - 70		200	200	200	200	100	50	50	25	25	25	25	10
≥ 75				100	100	50	25	25	25	25	10	10	10

TORNILLO HEXAGONAL + TUERCA ROSCA PARCIAL ZINCADO / VIS À MÉTAUX TÊTE HEXAGONALE + ECROUS FILETAGE PARTIEL ZINGUÉ
HEXAGON HEAD BOLT + HEXAGON NUT PARTIAL THREAD ZINC PLATED / VITI ACCIAIO TESTA ESAGONALE + DADI PARZIALMENTE FILETTATO ZINCATO
PARAFUSO HEXAGONAL + PORCA ROSCA PARCIAL ZINCADA

←→	M	M-5	M-6	M-8	M-10	M-12	M-14	M-16	M-18	M-20	M-24
		80	100	125	150	175	200	200	250	250	300
30			11,00								
35		11,68	11,25	22,35							
40		11,99	11,51	22,55	39,23						
45		12,16	12,60	23,95	46,68	68,15					
50		14,19	13,59	25,82	47,49	68,52	93,20				
60		52,18	15,65	29,18	50,02	70,08	114,25	135,30	180,88		
65			18,32	31,04	70,44	74,02	119,10	143,17	191,07	289,43	
70			19,35	33,45	72,35	77,37	119,54	149,92	200,29	303,02	
80		55,15	23,60	37,16	78,40	85,47	126,80	165,36	218,24	329,69	
90	Price x 100 units		29,40	43,07	82,22	92,77	136,30	179,92	236,68	356,86	
100			31,70	46,32	79,91	101,00	147,72	193,99	289,92	384,02	
110				58,69	88,46	117,37	175,73	209,02	290,60	410,71	
120				61,11	94,71	125,96	189,51	223,58	292,46	437,88	548,29
130				72,20	105,26	143,03	200,11	234,74	340,93	464,07	
140				89,22	111,71	149,81	220,66	249,77	342,80	490,74	
150				98,40	127,82	158,92	256,11	264,33	344,37	517,91	
160					139,15	200,19	281,06	333,25	433,14	545,08	
170						215,15	291,32	345,84	452,86	568,52	
180						173,24	243,57	305,94	364,25	478,25	598,93
200					212,88	299,17	417,37	399,18	518,52	673,97	
≤ 60		200	200	200	100	100	50	50	50		
65 - 100		200	100	100	100	50	50	25	25	25	
110 - 140				50	50	25	25	25	25	10	
≥ 150				50	25	10	10	10	10	5	

Ref. 0017

+ Medida / Dimensions / Size / Dimensioni / Medida



DIN 931/934

BAJA RESISTENCIA
LOW RESISTANCE



TORNILLO HEXAGONAL + TUERCA ROSCA ENTERA ZINCADO / VIS À MÉTAUX TÊTE HEXAGONALE + ECROUS ENTièrement FILETÉE ZINGUÉ
HEXAGON HEAD BOLT + HEXAGON NUT FULL THREAD ZINC PLATED / VITI ACCIAIO TESTA ESAGONALE + DADI INTERAMENTE FILETTATO ZINCATO
PARAFUSO HEXAGONAL + PORCA ROSCA TOTAL ZINCADA

←→	M	M-4	M-5	M-6	M-8	M-10	M-12	M-14	M-16	M-18	M-20
		70	80	100	125	150	175	200	200	250	250
10		6,57	5,18	6,38							
12		6,60	5,81	6,49	16,76						
16		6,68	6,41	6,73	16,90	30,61	50,26				
20		6,76	7,21	6,92	17,25	30,90	50,55	81,59			
25		6,88	7,84	7,81	17,60	31,30	50,95	82,64	86,92		
30		7,37	9,02	8,50	17,85	31,90	51,40	67,67	90,50	166,98	219,62
35		8,73	10,00	9,43	18,19	32,88	51,80	72,52	93,08	167,55	220,20
40		9,14	10,99	10,08	19,62	35,10	52,35	76,89	100,74	168,40	241,50
45	Price x 100 units	11,92	11,99	10,92	20,99	37,31	54,75	81,26	107,32	169,25	245,45
50		12,38	12,95	11,76	22,24	38,73	56,28	86,11	112,67	170,10	260,35
60			19,16	16,83	24,99	42,50	62,81	94,84	121,22	171,18	271,80
65				17,23	28,83	49,23	72,51	99,69	133,83	178,46	280,21
70				17,79	29,95	49,80	73,48	104,05	144,01	185,74	284,45
80				20,50	34,31	54,46	83,67	116,97	154,69	201,26	289,50
90				21,85	41,51	61,99	93,85	128,54	164,40	215,81	292,78
100				26,72	46,24	69,12	104,04	138,20	174,58	231,44	318,87
110					56,06	79,31	108,13	179,48	188,17	245,30	398,57
120						89,50	123,94	191,47	221,40	297,53	422,35
≤ 35		200	200	200	200	100	100	50	50	50	25
40 - 70		200	200	200	200	100	50	50	25	25	25
≥ 75				100	100	50	25	25	25	25	10

Ref. 0007

+ Medida / Dimensions / Size / Dimensioni / Medida



DIN 933/934

BAJA RESISTENCIA
LOW RESISTANCE





TORNILLO HEXAGONAL ROSCA PARCIAL ZINCADO / VIS À MÉTAUX TÊTE HEXAGONALE FILETAGE PARTIEL ZINGUÉ
HEXAGON HEAD BOLT PARTIAL THREAD ZINC PLATED / VITI ACCIAIO TESTA ESAGONALE GAMBO PARZIALMENTE FILETTATO ZINCATO
PARAFUSO HEXAGONAL ROSCA PARCIAL ZINCADO

Ref. 0011

+ Medida / Dimensions / Size / Dimensioni / Medida
+ Z

DIN 931



CLASE
CLASSE
CLASS 8.8



	M	M-5	M-6	M-8	M-10	M-12	M-14	M-16	M-18	M-20	M-22	M-24
	↔	80	100	125	150	175	200	200	250	250	250	300
30		9,16	8,70	13,26
35		10,44	8,85	15,04	29,90
40		12,09	9,11	17,11	30,60	42,58
45		12,98	11,81	17,48	33,10	43,60
50		14,83	12,20	19,09	35,50	44,23	79,92	91,92
60		19,90	13,80	21,91	36,98	51,70	80,36	106,30	246,71	247,57	.	.
65		85,90	112,40	248,70	250,30	.	.
70		.	16,50	25,07	43,29	61,00	86,97	118,50	250,45	251,25	326,63	351,33
80		.	19,64	30,20	49,23	70,24	96,83	120,70	252,50	256,80	344,65	386,87
90	Price x 100 units	.	25,47	38,01	55,99	79,09	105,03	141,50	256,34	258,60	373,76	422,41
100		.	32,45	45,38	65,62	92,57	114,88	145,10	282,94	274,45	406,56	456,98
110		.	33,13	50,44	76,51	104,28	133,62	157,50	305,45	296,20	439,36	512,69
120		.	.	55,00	82,61	112,81	154,39	169,30	335,74	332,24	471,70	548,64
130		.	.	62,43	92,13	131,23	160,50	180,20	360,55	362,21	526,22	577,80
140		.	.	65,07	105,16	147,95	185,85	222,37	430,91	426,36	562,72	657,98
150		.	.	70,50	114,79	161,15	206,91	234,58	487,94	482,79	591,82	769,99
160		.	.	74,36	118,15	175,95	223,08	264,61	573,34	575,31	838,53	840,42
170		178,40	226,35	280,25	589,16	591,01	959,26	962,79
180		.	.	90,78	121,35	180,25	230,86	324,45	609,84	634,43	1030,72	1032,97
200	.	.	.	135,99	184,31	256,25	380,66	686,07	691,97	1183,18	1186,05	
≤ 55		200	200	200	100	100	50	50
60 - 90		200	200	100	50	50	50	25	25	25	25	25
100 - 150		.	100	50	25	25	25	25	10	10	10	10
≥ 160		.	.	50	25	10	10	10	10	5	5	5

TORNILLO HEXAGONAL ROSCA ENTERA ZINCADO / VIS À MÉTAUX TÊTE HEXAGONALE ENTIÈREMENT FILETÉE ZINGUÉ
HEXAGON CAP SCREW FULL THREAD ZINC PLATED / VITI ACCIAIO TESTA ESAGONALE GAMBO INTERAMENTE FILETTATO ZINCATO
PARAFUSO HEXAGONAL ROSCA TOTAL ZINCADO

Ref. 0001

+ Medida / Dimensions / Size / Dimensioni / Medida
+ Z

DIN 933



CLASE
CLASSE
CLASS 8.8



	M	M-4	M-5	M-6	M-8	M-10	M-12	M-14	M-16	M-18	M-20	M-22	M-24	
	↔	70	80	100	125	150	175	200	200	250	250	250	300	
10		5,06	6,30	5,06	
12		5,48	6,50	5,20	10,00	
16		5,97	6,70	5,40	10,10	17,64	
20		6,53	6,90	5,80	10,20	18,40	33,42	61,20	
25		7,19	7,10	6,05	10,84	20,41	33,90	62,15	71,55	
30		8,10	7,89	7,00	12,10	21,65	34,20	64,35	71,90	135,25	169,51	.	.	
35		11,45	8,84	8,00	13,32	23,87	34,95	65,10	80,30	137,21	175,15	.	.	
40		11,83	9,82	9,05	15,16	26,05	37,70	65,95	80,75	137,60	175,80	275,50	278,80	
45	Price x 100 units	13,75	11,55	9,65	15,83	28,60	41,45	66,80	80,92	148,38	176,85	282,30	284,93	
50		14,50	13,27	9,70	17,00	29,21	43,50	67,50	81,35	157,01	177,40	290,45	288,25	
60		.	.	13,37	21,50	34,50	50,20	68,95	94,70	175,03	179,10	295,68	300,37	
65		.	.	.	23,60
70		.	.	13,41	25,41	39,71	57,04	95,15	110,25	188,03	196,46	324,79	329,07	
80		.	.	.	29,26	45,60	65,56	96,25	120,58	221,50	215,58	359,50	359,11	
90		.	.	.	34,10	54,20	75,02	103,54	129,53	263,80	263,80	416,26	423,75	
100		.	.	.	32,52	63,60	87,50	123,50	145,70	296,14	297,34	445,37	448,99	
110		.	.	.	37,20	63,80	87,65	127,70	158,85	408,41	409,90	569,65	581,50	
120		.	.	.	43,33	72,50	88,04	136,00	170,07	426,43	427,80	606,14	615,74	
≤ 35		200	200	200	200	100	100	50	50	50	25	.	.	
40 - 70		200	200	200	200	100	50	50	25	25	25	25	10	
≥ 75		.	.	.	100	50	25	25	25	25	10	10	10	



TORNILLO HEXAGONAL ROSCA PARCIAL NEGRO / VIS À MÉTAUX TÊTE HEXAGONALE FILETAGE PARTIEL NOIR
HEXAGON HEAD BOLT PARTIAL THREAD BLACK / VITI ACCIAIO TESTA ESAGONALE GAMBO PARZIALMENTE FILETTATO NERO
PARAFUSO HEXAGONAL ROSCA PARCIAL PRETO

← M	M-5	M-6	M-8	M-10	M-12	M-14	M-16	M-18	M-20	M-22	M-24	M-27	M-30
80	100	125	150	175	200	200	250	250	250	300	300	350	
30	8,82	8,62	12,10
35	9,93	8,68	18,00	28,16
40	11,37	8,75	22,00	30,20	40,19
45	12,50	9,69	25,50	32,40	40,50	75,25
50	14,53	12,58	28,35	34,25	41,22	76,30	80,62
60	20,60	13,50	30,10	36,50	47,53	77,10	87,27	201,85	201,89
65	85,95	105,00	202,44	203,57
70	.	14,64	33,25	40,50	54,07	86,35	108,50	202,95	209,55	318,89	337,27	.	.
80	.	18,20	35,40	45,12	65,15	94,40	120,00	203,54	216,35	337,26	362,18	733,66	.
90	Price	23,54	37,25	52,03	70,57	106,10	121,35	220,37	237,08	366,83	395,81	835,55	965,12
100	x 100	31,57	41,36	59,07	83,27	105,48	132,00	249,81	257,47	396,40	428,70	734,62	1041,81
110	units	39,20	43,95	69,41	94,16	128,08	152,10	269,61	278,55	430,12	461,98	765,55	1122,62
120	.	.	50,33	75,02	101,92	139,37	154,74	297,03	298,98	455,99	494,31	792,34	1232,57
130	.	.	60,45	83,99	119,85	151,14	163,26	335,40	317,80	515,13	518,39	848,00	1273,27
140	.	.	62,50	96,47	135,52	168,80	199,98	387,22	387,22	573,94	618,81	887,96	1349,96
150	.	.	65,40	105,60	147,95	188,76	212,69	441,61	441,61	649,57	655,20	924,46	1427,12
160	.	.	137,58	115,83	161,98	201,69	239,36	503,38	495,76	819,13	824,05	1464,08	1889,58
170	.	.	.	179,69	250,33	268,07	533,72	555,52	929,69	934,30	.	.	.
180	.	.	175,10	141,35	196,96	260,25	296,40	616,31	618,90	1011,78	1015,76	1695,08	2197,73
200	.	.	168,58	349,80	281,77	349,75	693,46	687,17	1167,47	1168,89	1966,73	2388,54	.
📦													
≤ 55	200	200	200	100	100	50	50	50
60 - 90	200	200	100	50	50	50	25	25	25	15	15	10	10
95 - 140	.	100	50	25	25	25	25	10	10	10	10	10	5
150-200	.	.	50	25	25	10	10	10	10	5	5	5	5

Ref. 0011

+ Medida / Dimensions / Size / Dimensioni / Medida + N



DIN 931

CLASE
CLASSE
CLASS 8.8



TORNILLO HEXAGONAL ROSCA ENTERA NEGRO / VIS À MÉTAUX TÊTE HEXAGONALE ENTIÈREMENT FILETÉE NOIR
HEXAGON CAP SCREW FULL THREAD BLACK / VITI ACCIAIO TESTA ESAGONALE GAMBO INTERAMENTE FILETTATO NERO
PARAFUSO HEXAGONAL ROSCA TOTAL PRETO

← M	M-4	M-5	M-6	M-8	M-10	M-12	M-14	M-16	M-18	M-20	M-22	M-24	M-27	M-30
70	80	100	125	150	175	200	200	250	250	250	300	300	350	
10	4,97	6,20	4,93	7,84
12	5,14	6,40	5,10	8,91
16	5,60	6,60	5,30	10,05	17,11
20	6,09	6,80	5,60	10,15	18,10	25,00	56,50	71,10
25	6,73	7,00	5,85	10,30	18,60	33,80	61,85	71,25
30	7,55	7,49	6,16	10,97	21,55	34,00	63,85	71,80	134,44	160,73
35	9,71	8,50	7,10	12,20	23,33	34,55	64,80	72,10	135,77	172,50
40	Price	10,96	9,31	8,10	13,40	24,50	35,35	65,55	80,60	137,40	175,50	271,66	277,38	.
45	x 100	13,50	11,22	9,15	15,30	26,55	37,90	66,30	80,83	137,80	176,55	278,65	280,55	.
50	units	14,25	11,80	9,68	15,90	28,80	41,85	67,20	81,12	149,50	177,20	284,50	286,60	500,35
60	.	.	12,38	21,11	29,29	44,00	67,80	83,04	163,25	178,30	293,50	295,30	501,75	791,65
70	.	.	13,20	24,15	35,37	50,71	94,50	96,32	182,95	185,15	320,65	316,93	541,46	793,55
80	.	.	15,30	26,68	40,87	64,68	95,30	112,50	215,82	200,40	356,66	339,57	574,54	796,35
90	.	.	.	33,60	54,12	74,75	101,92	125,30	257,80	258,90	413,65	399,63	620,00	799,25
100	.	.	.	39,00	63,47	87,40	121,61	131,48	283,67	284,77	433,82	434,75	.	.
110	63,70	87,60	125,35	155,55	392,24	394,44	547,01	548,20	.	.
120	39,50	63,90	87,40	128,45	163,55	414,41	416,26	588,59	591,00	.
📦														
≤ 20	200	200	200	200	200	100	100	100
25 - 50	200	200	200	200	100	100	50	50	25	25	25	10	10	.
55 - 80	.	.	200	100	100	50	50	25	25	25	10	10	5	5
≥ 90	.	.	.	100	50	50	25	25	25	10	10	10	5	5

Ref. 0001

+ Medida / Dimensions / Size / Dimensioni / Medida + N



DIN 933

CLASE
CLASSE
CLASS 8.8



TORNILLO HEXAGONAL ROSCA PARCIAL ZINCADO / VIS À MÉTAUX TÊTE HEXAGONALE FILETAGE PARTIEL ZINGUÉ
HEXAGON HEAD BOLT PARTIAL THREAD ZINC PLATED / VITI ACCIAIO TESTA ESAGONALE GAMBO PARZIALMENTE FILETTATO ZINCATO
PARAFUSO HEXAGONAL ROSCA PARCIAL ZINCADO

Ref. 0015

+ Medida / Dimensions / Size / Dimensioni / Medida
 + Z

DIN 931

CLASE CLASSE CLASS 10.9



←	M	M-6	M-8	M-10	M-12	M-14	M-16	M-18	M-20	M-22	M-24
		100	125	150	175	200	200	250	250	250	300
35		12,67	22,45	38,96
40		14,17	24,87	42,70	62,87
45		16,72	27,29	44,21	65,12	100,51
50		18,59	29,72	50,13	68,40	103,66	135,82
60		20,03	34,20	57,22	78,56	119,45	137,74	208,16	233,78	.	.
70		24,18	38,76	63,69	87,57	133,30	155,58	219,99	270,83	364,23	452,49
80		27,27	46,75	72,30	98,02	148,52	182,96	246,86	298,91	377,26	497,73
90		.	56,54	83,49	104,94	161,30	200,44	262,54	328,14	413,19	518,60
100	Price x 100 units	.	63,91	93,61	118,48	176,45	218,03	287,47	355,42	448,33	588,91
110		.	74,69	101,18	153,60	212,71	236,52	322,86	383,30	498,64	654,24
120		.	77,44	113,40	166,22	231,99	255,54	341,25	411,72	561,63	606,82
130		.	.	119,24	170,83	245,10	269,59	375,22	418,51	587,87	.
140		.	.	133,46	191,70	260,58	298,84	460,64	468,94	663,55	765,82
150		.	.	145,98	271,81	284,96	317,43	698,61	539,11	1018,93	951,83
160		.	.	.	280,67	348,92	401,56	725,12	641,75	1033,56	1110,95
180		733,36	1056,22	1177,28	.
200		968,11	1191,41	1534,72	.
≤ 65		100	50	50	25	25	25	10	10	10	10
70 - 130		50	25	25	25	25	10	10	10	5	5
≥ 140		.	.	25	10	10	5	5	5	5	5

TORNILLO HEXAGONAL ROSCA ENTERA ZINCADO / VIS À MÉTAUX TÊTE HEXAGONALE ENTIÈREMENT FILETÉE ZINGUÉ
HEXAGON CAP SCREW FULL THREAD ZINC PLATED / VITI ACCIAIO TESTA ESAGONALE GAMBO INTERAMENTE FILETTATO ZINCATO
PARAFUSO HEXAGONAL ROSCA TOTAL ZINCADO

Ref. 0005

+ Medida / Dimensions / Size / Dimensioni / Medida
 + Z

DIN 933

CLASE CLASSE CLASS 10.9



←	M	M-6	M-8	M-10	M-12	M-14	M-16	M-18	M-20	M-22	M-24
		100	125	150	175	200	200	250	250	250	300
20		7,27	19,09	26,60	39,11	.	78,18
25		8,27	19,50	27,98	40,01	65,98	89,61
30		9,33	23,97	29,30	44,35	68,05	97,06	142,37	.	.	.
35		10,71	25,87	33,65	48,71	73,94	101,48	144,39	.	.	.
40		11,75	27,46	36,59	53,38	79,81	105,73	146,47	193,15	.	.
45	Price x 100 units	12,55	28,28	39,28	56,99	85,67	108,65	151,58	.	.	.
50		13,65	29,25	42,49	61,14	87,15	115,24	168,91	203,79	.	.
60		.	34,10	48,43	68,40	98,23	137,48	186,54	230,04	.	.
70		.	35,20	54,31	74,28	115,03	152,39	206,15	255,65	.	.
80		.	39,86	60,36	93,43	139,41	168,84	227,79	280,19	.	.
90		.	.	73,55	102,55	148,52	184,11	267,11	302,60	.	.
100		.	.	81,69	111,96	161,30	190,21	303,99	327,10	.	.
≤ 35		100	50	50	25	25	25
40 - 60		50	25	25	10	10	10	5	5	5	5
≥ 70		.	10	10	5	5	5	5	5	5	1

TORNILLO HEXAGONAL ROSCA PARCIAL NEGRO / VIS À MÉTAUX TÊTE HEXAGONALE FILETAGE PARTIEL NOIR
HEXAGON HEAD BOLT PARTIAL THREAD BLACK / VITI ACCIAIO TESTA ESAGONALE GAMBO PARZIALMENTE FILETTATO NERO
PARAFUSO HEXAGONAL ROSCA PARCIAL PRETO

Ref. 0015

+ Medida / Dimensions / Size / Dimensioni / Medida + N

←	M	M-6	M-8	M-10	M-12	M-14	M-16	M-18	M-20	M-22	M-24
	100	125	150	175	200	200	250	250	250	250	300
35	11,90	22,33	35,86
40	12,22	23,32	36,70	62,22
45	15,63	23,34	43,12	63,37	100,42
50	18,29	25,50	43,22	64,71	106,59	117,16
60	19,06	29,23	49,32	68,37	107,34	124,39	199,60	209,29	.	.	.
70	20,39	36,59	62,05	75,55	114,99	146,18	215,59	233,56	358,22	389,75	.
80	24,49	45,58	62,38	85,72	128,12	156,72	235,86	282,44	370,00	447,06	.
90	.	54,99	82,38	103,83	152,33	172,91	257,98	283,62	408,95	480,01	.
100	Price x 100 units	63,61	91,48	114,11	153,68	188,08	285,38	306,34	430,31	509,17	.
110	.	73,16	95,15	132,61	184,07	204,24	308,07	372,77	493,58	625,74	.
120	.	76,66	102,84	163,35	199,89	220,46	339,69	373,90	530,57	626,86	.
130	.	.	115,10	164,32	212,15	232,56	371,55	378,21	565,43	.	.
140	.	.	132,28	185,77	231,40	274,16	442,39	442,39	655,69	718,49	.
150	.	.	144,74	271,52	258,73	291,90	695,98	536,10	1017,20	947,61	.
160	.	.	.	279,30	346,79	396,80	720,73	575,10	1030,33	1107,67	.
180	685,99	1050,70	1173,43	.
200	963,67	1183,17	1521,55	.
☒											
≤ 65	100	50	50	25	25	25	10	10	10	10	10
70 - 130	50	25	25	25	25	10	10	10	5	5	5
≥ 140	.	.	25	10	10	5	5	5	5	5	5



DIN 931

CLASE CLASSE CLASS **10.9**



TORNILLO HEXAGONAL ROSCA ENTERA NEGRO / VIS À MÉTAUX TÊTE HEXAGONALE ENTIÈREMENT FILETÉE NOIR
HEXAGON CAP SCREW FULL THREAD BLACK / VITI ACCIAIO TESTA ESAGONALE GAMBO INTERAMENTE FILETTATO NERO
PARAFUSO HEXAGONAL ROSCA TOTAL PRETO

Ref. 0005

+ Medida / Dimensions / Size / Dimensioni / Medida + N

←	M	M-6	M-8	M-10	M-12	M-14	M-16	M-18	M-20	M-22	M-24
	100	125	150	175	200	200	250	250	250	250	300
20	6,83	13,08	24,00	34,34	.	76,68
25	7,57	14,80	26,64	38,31	62,80	82,01
30	8,98	16,58	27,98	39,83	64,40	85,90	140,40
35	9,05	18,21	30,55	44,08	66,70	88,96	145,50
40	10,80	19,97	37,49	53,92	69,98	96,00	150,45	184,87	.	.	.
45	Price x 100 units	11,45	21,60	39,60	56,51	77,46	103,39	154,55	.	.	.
50	12,46	23,20	42,66	60,76	87,53	109,64	158,99	187,32	.	.	.
60	.	25,75	48,33	65,40	93,62	124,53	177,11	214,15	.	.	.
70	.	31,56	49,04	70,30	100,93	138,37	203,87	230,95	.	.	.
80	.	36,58	56,55	81,15	109,10	153,26	225,57	253,32	.	.	.
90	.	.	67,94	93,73	127,83	176,40	264,92	274,64	.	.	.
100	.	.	79,60	109,66	152,49	182,18	302,30	317,65	.	.	.
☒											
≤ 35	100	50	50	25	25	25
40 - 60	50	25	25	10	10	10	5	5	5	5	5
≥ 70	.	10	10	5	5	5	5	5	5	5	1



DIN 933

CLASE CLASSE CLASS **10.9**





TORNILLO HEXAGONAL ROSCA PARCIAL NEGRO / VIS À MÉTAUX TÊTE HEXAGONALE FILETAGE PARTIEL NOIR
HEXAGON HEAD BOLT PARTIAL THREAD BLACK / VITI ACCIAIO TESTA ESAGONALE GAMBO PARZIALMENTE FILETTATO NERO
PARAFUSO HEXAGONAL ROSCA PARCIAL PRETO

Ref. 0019

+ Medida / Dimensions / Size / Dimensioni / Medida

DIN 931

BLACK

CLASE
CLASSE
CLASS **12.9**



←	M	M-6	M-8	M-10	M-12	M-14	M-16	M-18	M-20	M-22	M-24	M-27	M-30	
	↔	100	125	150	175	200	200	250	250	250	300	300	350	
30		52,80												
35		56,10	92,40	145,20	194,70									
40		59,40	99,00	151,80	214,50	277,20								
45			108,90	161,70	227,70	297,00	445,50							
50		72,60	115,50	168,30	240,90	323,40	465,80							
55														
60		82,50	125,40	188,10	267,30	359,70	481,80	907,50	1016,40					
65														
70		92,40	141,90	207,90	303,60	379,50	554,40	1016,40	1197,90	1749,00	2059,20			
80			161,70	224,40	320,10	455,40	594,00	1052,70	1255,60	1930,50	2230,80			
90	Price x 100 units		191,40	257,40	363,00	495,00	630,30	1161,60	1379,40	2046,00	2438,70			
100			198,00	260,70	396,00	531,30	666,60	1234,20	1488,30	2178,00	2630,10			
110			214,50	293,70	448,80	570,90	739,20	1306,80	1643,40	2359,50	2818,20			
120			237,60	343,20	491,70	646,80	851,40	1560,90	1864,50	2504,70	3009,60			
130				372,90	554,40	683,10	1270,50	1742,40	2013,00	2613,60	3187,80			
140				448,80	726,00	1155,00	1343,10	1887,60	2141,70	2831,40	3405,60			
150				501,60	891,00	1221,00	1452,00	1996,50	2359,50	2976,60	3587,10			
160									2649,90	3412,20	4101,90			
170									2831,40					
180											4574,90			
190														
200														
≤ 65		100	50	50	25	25	25	10	10	10	5			
70 - 130		50	25	25	10	10	10	5	5	5	5	5	5	
≥ 140				10	5	5	5	1	1	1	1	1	1	

TORNILLO HEXAGONAL ROSCA ENTERA NEGRO / VIS À MÉTAUX TÊTE HEXAGONALE ENTIÈREMENT FILETÉE NOIR
HEXAGON CAP SCREW FULL THREAD BLACK / VITI ACCIAIO TESTA ESAGONALE GAMBO INTERAMENTE FILETTATO NERO
PARAFUSO HEXAGONAL ROSCA TOTAL PRETO

Ref. 0009

+ Medida / Dimensions / Size / Dimensioni / Medida

DIN 933

BLACK

CLASE
CLASSE
CLASS **12.9**



←	M	M-6	M-8	M-10	M-12	M-14	M-16	M-18	M-20	M-22	M-24	M-27	M-30	
	↔	100	125	150	175	200	200	250	250	250	300	300	350	
15		42,90	66,00	108,90										
20		46,20	69,30	112,50	151,80									
25		56,10	72,60	115,50	165,00	224,40	303,60							
30		59,40	82,50	128,70	184,80	247,50	358,65							
35		62,70	85,00	135,30	201,30	267,30	382,80							
40		69,30	99,00	148,50	217,80	287,10	389,40	825,00	808,50	1155,00				
45	Price x 100 units		112,20	158,40	234,30	305,45	429,00	848,10						
50			118,80	168,30	247,50	323,40	455,40	867,90	914,10	1353,00	1815,00			
60			128,70	174,90	273,90	353,10	511,50	910,25	1029,60	1551,00	1881,00			
70			135,30	227,70	315,00	382,80	547,80	963,60	1122,00	1749,00	1996,50			
80					339,90	399,30	597,30	1026,30	1211,10	1881,00	2145,00			
90							643,50		1498,20	2303,40	2415,60			
100							732,60		1557,60	2663,10				
≤ 35			100	50	50	25	25	25						
40 - 60			50	25	25	10	10	10	5	5	5	5	5	5
≥ 70				10	10	5	5	5	5	5	1	1	1	1

TORNILLO HEXAGONAL ROSCA PARCIAL NEGRO / VIS À MÉTAUX TÊTE HEXAGONALE FILETAGE PARTIEL NOIR
HEXAGON HEAD BOLT PARTIAL THREAD BLACK / VITI ACCIAIO TESTA ESAGONALE GAMBO PARZIALMENTE FILETTATO NERO
PARAFUSO HEXAGONAL ROSCA PARCIAL PRETO

WHITWORTH - UNC

Ref. 0013

+ Medida / Dimensions / Size / Dimensioni / Medida



DIN 931

CLASE
CLASSE
CLASS **8.8**



		ROSCA UNC/ FILETAGE UNC / THREAD UNC / FILETTATURA UNC											
←	M	1/4"	5/16"	3/8"	7/16"	1/2"	1/2" UNC	9/16"	5/8"	3/4"	7/8"	1"	
		20	18	16	14	12	13	12	11	10	9	8	
30		49,50	
35		51,50	68,61	
40		56,10	95,70	135,30	191,40	198,00	204,60	
45		62,70	105,60	151,80	198,00	201,30	211,20	
50		69,30	.	158,40	214,50	224,40	237,60	326,70	435,60	.	.	.	
60	Price x 100 units	88,00	141,90	181,50	254,10	267,30	270,60	376,20	455,40	1072,50	1428,90	.	
70		.	155,10	207,90	287,10	303,60	313,50	410,50	521,40	1188,00	1620,30	1980,00	
80		.	.	240,90	311,30	333,80	381,15	435,60	587,40	1303,50	1815,00	2244,00	
90		.	.	.	346,50	386,10	495,00	485,10	643,50	1405,80	2079,00	2409,00	.
100		438,90	500,00	.	709,50	1584,00	2310,00	2574,00	.
110		508,20	505,00	.	772,20	1749,00	.	2871,00	.
120		884,40	1947,00	.	3069,00	.
130	3267,00	.	
≤ 50		50	50	50	50	50	50	50	25	.	10	.	
55 - 90		50	50	50	50	25	25	25	10	10	5	5	
≥ 100		50	50	25	25	25	25	10	10	5	5	5	

TORNILLO HEXAGONAL ROSCA ENTERA NEGRO / VIS À MÉTAUX TÊTE HEXAGONALE ENTIÈREMENT FILETÉE NOIR
HEXAGON CAP SCREW FULL THREAD BLACK / VITI ACCIAIO TESTA ESAGONALE GAMBO INTERAMENTE FILETTATO NERO
PARAFUSO HEXAGONAL ROSCA TOTAL PRETO

WHITWORTH - UNC

Ref. 0003

+ Medida / Dimensions / Size / Dimensioni / Medida



DIN 933

CLASE
CLASSE
CLASS **8.8**



		ROSCA UNC/ FILETAGE UNC / THREAD UNC / FILETTATURA UNC											
←	M	1/4"	5/16"	3/8"	7/16"	1/2"	1/2" UNC	9/16"	5/8"	3/4"	7/8"	1"	
		20	18	16	14	12	13	12	11	10	9	8	
15		42,90	66,00	
20		46,20	69,30	102,30	
25		49,50	75,90	108,90	158,40	161,70	168,30	
30		52,80	82,50	118,80	168,30	168,30	185,13	264,00	359,70	.	.	.	
35		56,10	89,10	122,10	174,90	174,90	190,00	273,90	382,80	.	.	.	
40	Price x 100 units	66,00	95,70	128,70	181,50	191,40	198,00	283,80	399,30	858,00	1221,00	.	
45		68,00	105,60	141,90	198,00	211,00	210,00	310,20	415,80	895,00	.	.	
50		.	112,20	151,80	211,20	217,80	240,90	326,70	432,30	957,00	1257,30	1716,00	
60		.	125,40	171,60	247,50	257,40	280,50	359,70	471,90	1056,00	1521,30	1881,00	.
70		.	.	194,70	287,10	310,20	290,00	372,90	528,00	1155,00	1683,00	.	.
80		.	.	231,00	313,50	333,30	297,00	405,90	577,50	1254,00	1848,00	2194,50	.
90		462,00	.	1353,00	1930,50	.	.
100	1485,00	2128,50	2541,00	.	
≤ 35		50	50	50	50	50	50	50	25	.	.	.	
40 - 60		50	50	50	25	25	25	25	10	10	5	5	
≥ 65		50	50	25	25	25	25	25	10	5	5	5	

TORNILLO HEXAGONAL ROSCA PARCIAL NEGRO / VIS À MÉTAUX TÊTE HEXAGONALE FILETAGE PARTIEL NOIR
HEXAGON HEAD BOLT PARTIAL THREAD BLACK / VITI ACCIAIO TESTA ESAGONALE GAMBO PARZIALMENTE FILETTATO NERO
PARAFUSO HEXAGONAL ROSCA PARCIAL PRETO

UNF - UNS (SAE)

Ref. 0012

+ Medida / Dimensions / Size / Dimensioni / Medida

DIN 931

BLACK

CLASE
CLASSE
CLASS **8.8**



ROSCA UNC/ FILETAGE UNC / THREAD UNC / FILETTATURA UNC

←→	M	1/4"	5/16"	3/8"	7/16"	1/2"	5/8"	3/4"	7/8"	1"
	↗	28	24	24	20	20	18	16	14	12
35	Price	49,50	85,80	125,40	165,00	177,87
40	x 100	.	.	128,70	178,20	188,10
45	units	62,70	99,00	138,60	.	.	409,20	.	.	.
50		66,00	108,90	151,80	204,60	211,20	419,10	.	.	.
60		82,50	135,30	191,40	.	250,80	435,60	1122,00	.	.
70		.	155,10	207,90	180,50	287,10	495,00	1221,00	1527,90	1914,00
80		.	.	237,60	306,90	320,10	557,70	1353,00	1692,90	2112,00
90		.	.	273,90	333,30	363,00	603,90	1485,00	1821,60	2277,00
100		.	.	297,00	359,70	405,90	660,00	1617,00	1960,20	2442,00
📦										
≤ 50		50	50	50	50	50	25	.	10	.
55 - 90		50	50	50	50	25	10	10	5	5
≥ 100		50	50	25	25	25	10	5	5	5

TORNILLO HEXAGONAL ROSCA ENTERA NEGRO / VIS À MÉTAUX TÊTE HEXAGONALE ENTIÈREMENT FILETÉE NOIR
HEXAGON CAP SCREW FULL THREAD BLACK / VITI ACCIAIO TESTA ESAGONALE GAMBO INTERAMENTE FILETTATO NERO
PARAFUSO HEXAGONAL ROSCA TOTAL PRETO

UNF - UNS (SAE)

Ref. 0002

+ Medida / Dimensions / Size / Dimensioni / Medida

DIN 933

BLACK

CLASE
CLASSE
CLASS **8.8**



ROSCA UNC/ FILETAGE UNC / THREAD UNC / FILETTATURA UNC

←→	M	1/4"	5/16"	3/8"	7/16"	1/2"	5/8"	3/4"	7/8"	1"
	↗	28	24	24	20	20	18	16	14	12
15	Price	46,20
20	x 100	49,50	69,30	102,30
25	units	52,80	72,60	105,60	151,80	165,33
30		54,80	79,20	115,50	165,00	178,20	346,33	.	.	.
35		56,80	82,50	122,10	171,60	184,80
40		62,70	89,10	135,30	184,80	198,00	372,90	990,00	.	1518,00
50		79,20	108,90	151,80	207,90	227,70	429,00	1089,00	1452,00	1650,00
60		.	.	168,30	.	267,30	.	1188,00	1518,00	1848,00
70		.	.	207,90	.	.	.	1323,30	1650,00	2013,00
80		1435,50	1815,00	2178,00
📦										
≤ 35		50	50	50	50	50	25	.	.	.
40 - 55		50	50	50	25	25	10	10	5	5
≥ 60		50	50	25	25	25	10	5	5	5

TORNILLO HEXAGONAL PASO FINO ROSCA PARCIAL NEGRO / VIS À MÉTAUX TÊTE HEXAGONALE FILETAGE PARTIEL MÉTRIQUE ISO À PAS FIN NOIR
HEXAGON HEAD BOLT PARTIAL ISO METRIC THREADS FINE PITCH BLACK
VITI NERE IN ACCIAIO A PASSO FINE CON TESTA ESAGONALE E FILETTATURA PARZIALE / PARAFUSO HEXAGONAL. PASSOS FINOS ROSCA PARCIAL, PRETO

PASO FINO / FINE PITCH

Ref. 0006

+ Medida / Dimensions / Size / Dimensioni / Medida

←	M	M-8	M-10	M-10	M-12	M-12	M-14	M-16	M-18	M-20	
		100	100	125	125	150	150	150	150	150	
30		50,82	
35		
40		56,22	96,37	91,48	128,49	128,49	
45		
50		66,07	101,64	107,07	136,52	149,23	213,44	276,97	.	.	
55		
60	Price x 100 units	81,31	128,49	121,97	167,71	176,68	241,40	317,47	482,79	.	
70		97,17	144,30	137,21	190,58	200,77	261,72	327,79	541,23	691,97	
80		109,77	168,65	160,08	224,86	213,44	279,85	368,45	592,05	696,23	
90		119,43	180,41	190,06	259,66	259,66	312,54	409,10	602,22	816,44	
100		139,21	214,15	203,28	276,97	276,97	343,04	444,68	688,61	853,78	
110	
120		.	.	.	350,66	350,66	449,71	548,86	872,66	1076,10	.
130	
140	696,23	945,25	1173,94	.	
≤ 60		50	50	50	50	50	25	25	25	.	
65 - 95		50	25	25	25	25	10	10	10	5	
≥ 100		25	25	25	10	10	10	5	5	5	



DIN 960

CLASE
CLASSE
CLASS **8.8**



TORNILLO HEXAGONAL PASO FINO ROSCA ENTERA NEGRO / VIS À MÉTAUX TÊTE HEXAGONALE FILETAGE TOTAL MÉTRIQUE ISO À PAS FIN NOIR
HEXAGON HEAD BOLT ISO METRIC FULL THREADS. FINE PITCH BLACK / VITI NERE IN ACCIAIO A PASSO FINE CON TESTA ESAGONALE E FILETTATURA INTERA
PARAFUSO HEXAGONAL. PASSOS FINOS ROSCA TOTAL, PRETO

PASO FINO / FINE PITCH

Ref. 0016

+ Medida / Dimensions / Size / Dimensioni / Medida

←	M	M-8	M-10	M-10	M-12	M-12	M-14	M-16	M-18	M-20
		100	100	125	125	150	150	150	150	150
20		38,12	66,07	68,10	103,06	99,10
25		40,66	74,95	71,15	107,07	101,64
30		43,20	76,23	76,23	109,26	109,26	172,79	231,23	370,51	.
35		48,28	80,75	78,77	123,15	116,89	182,95	241,40	377,44	.
40	Price x 100 units	50,82	85,60	83,85	125,82	119,43	190,58	266,11	401,59	497,90
45		59,99	91,48	91,48	135,45	129,59	203,28	278,42	425,62	503,12
50		63,53	96,56	96,56	152,03	137,21	215,99	289,20	441,18	531,07
60		.	.	.	171,33	162,62	238,85	297,30	497,90	613,09
70		276,83	320,17	543,43	682,61
80		385,47	588,91	733,69
≤ 30		100	100	100	50	50	50	25	25	.
35 - 60		50	50	50	25	25	25	10	10	10
≥ 65		.	.	.	25	25	10	10	5	5



DIN 961

CLASE
CLASSE
CLASS **8.8**





TORNILLO ALLEN CABEZA CILÍNDRICA ZINCADO / VIS À TÊTE CYLINDRIQUE À 6 PANS CREUX ZINGUÉ
SOCKET HEX HEAD CAP SCREW ZINC PLATED / VITI TESTA CILINDRICA CON ESAGONO INCASSATO ZINCATO
PARAFUSO ALLEN CABEÇA CILINDRICA ZINCADO

Ref. 0022

+ Medida / Dimensions / Size / Dimensioni / Medida
+ Z

DIN 912



CLASE
CLASSE
CLASS 8.8



↔	M	M-4	M-5	M-6	M-8	M-10	M-12
	↔	70	80	100	125	150	175
6	8,84
8	9,05	7,37
10	9,25	7,50	6,49	10,73	.	.	.
12	9,50	7,60	7,81	10,89	.	.	.
16	9,70	7,70	7,95	11,05	20,52	.	.
20	9,90	7,80	8,05	11,25	21,51	29,37	.
25	10,10	7,90	8,15	12,35	23,71	31,24	.
30	10,25	8,10	8,36	13,81	25,52	35,09	.
35	10,45	10,52	9,52	16,45	27,28	37,62	.
40	10,60	11,24	10,62	17,55	29,21	39,77	.
45	14,39	13,41	11,66	18,92	31,08	42,79	.
50	25,54	14,04	14,14	20,13	33,39	45,76	.
60	.	.	17,99	23,05	38,06	53,24	.
65	.	.	.	27,34	41,36	59,62	.
70	.	.	.	27,72	44,77	63,69	.
80	.	.	.	34,65	51,70	73,70	.
90	58,47	83,49	.
100	65,73	97,43	.
110	111,98	.
120	125,95	.
≤ 16	200	200	200	200	100	.	.
18 - 35	200	200	200	200	100	100	.
40 - 65	200	200	200	100	100	50	.
≥ 70	.	.	.	100	50	50	.

TORNILLO ALLEN CABEZA CILÍNDRICA NEGRO / VIS À TÊTE CYLINDRIQUE À 6 PANS CREUX NOIR
SOCKET HEX HEAD CAP SCREW BLACK / VITI TESTA CILINDRICA CON ESAGONO INCASSATO NERO
PARAFUSO ALLEN CABEÇA CILINDRICA PRETO

Ref. 0022

+ Medida / Dimensions / Size / Dimensioni / Medida
+ N

DIN 912



CLASE
CLASSE
CLASS 8.8



↔	M	M-4	M-5	M-6	M-8	M-10	M-12	M-14	M-16	M-18	M-20	M-22	M-24
	↔	70	80	100	125	150	175	200	200	250	250	250	300
6	11,91	6,79
8	12,10	8,17	7,66
10	12,30	8,30	7,80	9,79
12	12,50	8,40	7,90	10,10
16	12,70	8,50	8,00	10,30	18,54
20	12,90	8,60	8,10	10,50	19,31	27,50
25	13,10	8,70	8,20	10,95	21,18	28,88	69,76	71,61
30	13,30	8,80	8,30	12,16	22,77	31,30	75,31	79,34	116,60	161,24	.	.	.
35	13,50	8,90	8,58	14,63	24,31	31,60	81,31	84,93	128,34	175,12	.	.	.
40	13,70	9,59	9,52	15,90	25,96	35,20	90,09	92,40	150,15	183,23	383,13	316,58	.
45	14,10	10,67	10,29	17,10	27,61	37,90	102,47	101,06	160,82	189,82	.	.	.
50	17,97	12,97	12,82	18,60	30,10	40,48	104,41	107,65	163,57	212,39	390,10	468,13	.
60	.	17,96	14,30	20,24	33,39	47,08	118,69	122,43	186,12	218,25	395,15	479,11	.
65	.	.	18,43	24,31	36,58	53,02	124,74	128,44	196,35	222,84	.	.	.
70	.	.	21,18	24,53	39,71	56,76	133,54	137,21	206,47	225,07	408,87	525,78	.
80	.	.	27,72	32,50	46,04	65,95	147,84	152,46	247,81	229,13	449,02	572,87	.
90	.	.	31,49	38,50	52,20	74,80	165,40	175,00	257,84	273,66	488,84	608,01	.
100	.	.	35,48	45,90	60,70	88,77	179,67	185,24	278,12	278,12	528,99	658,26	.
110	.	.	.	50,55	67,65	101,59	194,48	199,98	304,04	304,04	569,14	762,45	.
120	.	.	.	55,39	77,22	114,73	208,82	215,27	326,63	326,63	609,40	776,93	.
130	.	.	.	62,43	85,36	131,01	216,22	236,21	352,32	352,32	649,11	933,64	.
140	.	.	.	66,50	94,22	147,90	231,44	281,64	421,72	421,72	802,02	946,96	.
150	.	.	.	83,71	104,50	163,30	262,56	299,55	524,81	525,49	827,34	1182,53	.
160	.	.	.	86,20	128,10	178,70	372,28	364,06
180
200
≤ 20	200	200	200	200	200
22 - 45	200	200	200	200	100	50	50	50	25	25	25	10	10
50 - 80	200	200	200	100	100	50	50	25	25	10	10	5	5
85 - 140	.	.	100	50	50	25	25	25	10	10	10	5	5
≥ 150	.	.	.	50	25	25	25	10	10	10	5	5	5



TORNILLO ALLEN CABEZA CILÍNDRICA NEGRO / VIS À TÊTE CYLINDRIQUE À 6 PANS CREUX NOIR
SOCKET HEX HEAD CAP SCREW BLACK / VITI TESTA CILINDRICA CON ESAGONO INCASSATO NERO
PARAFUSO ALLEN CABEÇA CILINDRICA PRETO

←→	M	M-4	M-5	M-6	M-8	M-10	M-12	M-14	M-16
		70	80	100	125	150	175	200	200
10		10,56	7,77	10,87	23,49
15		10,70	8,10	11,20	23,70	29,25	.	.	.
20		10,80	8,40	11,50	23,85	33,00	45,61	.	.
25		10,90	8,78	11,80	24,00	36,20	49,32	102,71	93,98
30		11,00	10,60	12,89	24,50	39,00	53,44	103,50	107,58
35		11,20	11,42	14,69	25,09	41,55	57,09	104,00	115,80
40		15,50	12,97	16,31	26,49	44,43	60,20	104,50	120,30
45		.	14,52	17,94	30,60	47,15	64,78	105,08	126,50
50	Price x 100 units	22,17	17,56	21,98	31,50	51,25	69,21	106,69	130,20
60		36,27	35,10	28,19	35,60	57,49	80,45	121,02	151,24
70		59,29	39,99	36,20	41,94	67,86	96,89	136,87	169,42
80		80,00	41,79	47,39	54,65	78,68	112,71	150,99	187,11
90		.	64,49	53,83	65,79	89,18	127,85	168,65	206,71
100		.	76,43	60,67	77,59	100,58	151,73	183,45	230,27
110		249,98
120		277,07
130	
140	
150	
≤ 45		50	50	50	50	25	25	20	20
50 - 90		20	20	20	20	10	10	10	10
≥ 100		10	10	10	10	5	5	5	5

Ref. 0024

+ Medida / Dimensions / Size / Dimensioni / Medida
+ N



DIN 912

CLASE
CLASSE
CLASS **12.9**



TORNILLO CABEZA CILÍNDRICA ABOMBADA MORTAJA ALLEN ZINCADO / VIS TÊTE CYLINDRIQUE BOMBÉE MORTAISE ALLEN ZINGUEE
ALLEN PAN HEAD MACHINE SCREW ZINC PLATED / VITE CILINDRICA ZINCATA, TESTA ALLEN
PARAFUSO CABEÇA CILINDRICA CONVEXA ENCAIXE ALLEN ZINCADO

←→	M	M-4	M-5	M-6	M-8	M-10	
		70	80	100	125	150	
10		6,38	7,83	9,37	.	.	
12		6,42	8,00	9,64	.	.	
16		6,46	8,35	10,24	18,48	.	
20		6,69	8,70	11,81	19,80	37,47	
25	Price x 100 units	7,13	9,74	13,37	21,99	41,91	
30		9,23	12,20	14,72	24,79	45,10	
35		11,75	13,92	16,87	29,17	48,58	
40		11,94	16,97	18,83	31,33	54,07	
45		.	.	.	34,12	56,61	
50		.	24,24	24,35	36,56	60,65	
60		.	.	36,78	42,87	65,18	
≤ 35			500	500	200	200	200
40 - 60			500	200	200	200	100

Ref. 7380

+ Medida / Dimensions / Size / Dimensioni / Medida
+ Z



DIN 7380

CLASE
CLASSE
CLASS **10.9**



TORNILLO DE CABEZA AVELLANADA CON HUECO HEXAGONAL ZINCADO / VIS À MÉTAUX TÊTE FRAISÉE SIX PANS CREUX ZINGUÉ
HEXAGON SOCKET COUNTERSUNK HEAD SCREW ZINC PLATED / VITI A TESTA SVASATA PIANA CON ESAGONO INCASSATO ZINCATO
PARAFUSO CABEÇA CHATA COM SEXTAVADO INTERNO ZINCADO

Ref. 7991

+ Medida / Dimensions / Size / Dimensioni / Medida
+ Z

DIN 7991



CLASE
CLASSE
CLASS **10.9**



	M	M-3	M-4	M-5	M-6	M-8	M-10	M-12	M-14	M-16	M-20
	↔										
	↔	50	70	80	100	125	150	175	200	200	250
6		6,20	7,79
8		7,70	8,10	6,96	20,36
10		8,00	8,35	7,37	20,45	18,73
12		8,30	8,60	7,52	20,55	20,47
16		8,69	8,70	7,71	20,60	21,00	37,51
20		8,91	8,80	7,82	20,70	21,50	37,62	49,95	.	.	.
25		10,21	8,95	8,79	20,80	22,00	37,74	57,19	.	.	.
30	Price x 100 units	14,42	9,24	9,49	20,90	22,50	37,88	57,32	306,11	115,15	.
35		.	10,68	12,82	20,95	25,42	41,67	58,10	308,00	117,25	.
40		.	12,54	15,29	21,05	27,78	45,19	76,58	310,00	119,02	306,79
45		.	.	16,61	21,30	29,80	47,42	78,60	312,00	129,47	.
50		.	27,84	21,99	22,50	30,92	51,92	81,50	316,00	133,22	331,38
60		.	.	30,39	35,32	36,66	58,85	83,50	320,00	155,22	349,42
70		.	.	.	45,45	43,01	68,44	96,79	330,00	219,12	397,35
80		.	.	.	90,64	67,19	98,53	131,02	413,56	269,28	544,50
90		100,63	147,91	.	.	408,11	.
100		150,81	193,38	234,96	.	578,96	912,01
≤ 25		200	200	200	200	200	200	100	.	.	.
30 - 70		200	200	200	200	100	100	50	50	50	25
80 - 130		.	.	.	100	50	50	50	.	25	10
≥ 140		50	50	25	.	25	10

TORNILLO DE CABEZA AVELLANADA CON HUECO HEXAGONAL NEGRO / VIS À MÉTAUX TÊTE FRAISÉE SIX PANS CREUX NOIR
HEXAGON SOCKET COUNTERSUNK HEAD SCREW BLACK / VITI A TESTA SVASATA PIANA CON ESAGONO INCASSATO NERO
PARAFUSO CABEÇA CHATA COM SEXTAVADO INTERNO

Ref. 7991

+ Medida / Dimensions / Size / Dimensioni / Medida

DIN 7991



CLASE
CLASSE
CLASS **10.9**



	M	M-3	M-4	M-5	M-6	M-8	M-10	M-12	M-14	M-16	M-20	M-24
	↔											
	↔	50	70	80	100	125	150	175	200	200	250	300
6		6,71	4,73
8		7,65	6,40	7,00	9,85
10		7,95	7,13	7,12	10,15	8,31
12		8,25	7,51	7,22	10,40	9,62
16		8,58	7,65	7,59	10,80	15,42	36,96
20		8,75	7,73	7,73	11,00	16,67	37,20	40,20
25		10,09	8,79	8,66	11,28	18,56	37,45	56,36
30	Price x 100 units	13,40	9,13	9,32	12,52	20,81	37,76	56,95	103,49	103,95	.	.
35		.	10,59	12,68	14,15	24,74	40,82	57,29	114,81	112,27	.	.
40		.	12,43	14,41	15,86	26,49	44,10	60,98	116,89	117,81	297,53	.
45		.	.	16,43	17,33	28,67	47,12	66,07	120,58	121,51	.	.
50		.	15,30	21,77	20,81	30,65	50,82	71,15	131,21	132,13	373,80	1303,89
60		.	.	27,65	34,42	35,97	58,21	82,70	153,38	154,31	380,10	1422,71
70		.	.	.	45,28	42,46	67,45	96,56	172,22	218,53	387,62	1482,98
80		.	.	.	89,54	66,42	98,41	130,75	188,65	267,96	435,67	1634,27
90		99,30	124,28	.	.	407,02	.	1665,00
100		149,86	192,19	233,77	.	578,42	911,06	1701,41
110
120
130
140
160
≤ 25		200	200	200	200	200	200	100
30 - 70		200	200	200	200	100	100	50	50	25	10	.
80 - 130		.	.	.	100	50	50	50	.	25	10	10
≥ 140		50	50	25	.	25	10	.

TORNILLO CUELLO CUADRADO CON CABEZA REDONDA ZINCADO / VIS COL CARRÉ AVEC TÊTE RONDE ZINGUEE
ROUND HEAD SCREW WITH SQUARE NECK BOLT ZINC PLATED / VITE A COLLO QUADRATO CON TESTA TONDA ZINCATA
PARAFUSO GOLA QUADRADA COM CABEÇA REDONDA ZINCADO

↔	M	M-6	M-8	M-10	M-12
	Price x 100 units	100	125	150	175
16		8,61	14,40	.	.
20		8,90	14,80	21,33	.
25		10,20	15,21	23,19	.
30		10,50	15,92	23,75	46,38
35		10,70	16,50	24,86	47,30
40		10,80	17,72	25,41	47,52
45		10,90	18,67	29,10	48,24
50		11,00	21,69	31,21	48,59
60		12,20	22,10	33,04	70,68
70		13,88	27,70	37,58	70,86
80		15,55	27,80	42,12	71,42
90		17,22	29,27	77,69	94,42
100		20,45	32,10	81,25	101,29
110		.	38,95	84,75	117,05
120		21,80	43,82	.	118,94
130		.	51,18	.	122,18
140		.	55,46	.	144,51
150		.	58,43	.	145,98
160		.	.	.	165,80
⊞					
≤ 50		200	200	100	50
55 - 100		100	100	50	25
110 - 180		100	50	25	25
190 - 260		.	25	25	10
≥ 280		.	.	10	10

Ref. 0087

+ Medida / Dimensions / Size / Dimensioni / Medida



DIN 603

BAJA RESISTENCIA
LOW RESISTANCE



TORNILLO CUELLO CUADRADO CON CABEZA REDONDA + TUERCA DE ACERO ZINCADO / VIS TÊTE RONDE COLLET CARRÉ ZINGUÉ
ROUND HEAD SCREW WITH SQUARE NECK BOLT + STEEL NUT ZINC PLATED / BULLONE TESTA TONDA QUADRO ZINCATO
PARAFUSO GOLA QUADRADA COM CABEÇA REDONDA + PORÇA DE AÇO ZINCADA

↔	M	M-5	M-6	M-7	M-8	M-10	M-12	M-16
	Price x 100 units	80	100	100	125	150	175	200
16		8,51	11,15	.	21,25	.	.	.
20		8,71	11,55	.	22,10	39,40	.	.
25		9,70	12,25	.	22,77	43,69	.	.
30		10,76	12,90	26,17	23,69	47,45	64,28	.
35		11,95	13,53	26,99	26,47	50,56	69,81	.
40		12,94	13,84	30,11	27,26	52,27	71,02	.
45		13,73	14,63	30,53	27,39	54,85	71,40	.
50		15,44	15,30	31,53	30,49	57,95	71,94	276,06
55		.	17,62	38,19	33,60	60,85	92,27	.
60		18,61	19,14	41,30	34,19	63,49	94,05	303,56
65		.	19,29	48,17	37,42	64,55	98,75	.
70		21,19	21,58	50,25	37,88	65,67	106,60	332,78
80		33,78	22,62	52,87	43,63	76,36	107,03	335,24
90		.	27,46	57,42	47,19	77,15	109,01	420,90
100		.	29,70	58,60	50,82	78,80	110,22	478,39
110		.	36,42	.	55,37	79,20	132,50	501,92
120		.	45,34	.	64,02	106,72	140,91	522,30
130		.	60,61	.	78,69	114,74	173,82	554,82
140		.	82,90	.	85,64	124,59	185,76	575,40
150		.	219,34	.	91,96	135,20	201,03	653,62
160		.	.	.	99,47	149,46	225,24	752,87
180		.	.	.	118,18	176,52	240,65	892,44
200		.	.	.	158,58	201,05	299,59	917,57
220		228,75	343,31	.
225	
240		252,87	435,96	.
250		258,50	445,25	.
260		285,69	510,25	.
280		296,98	585,60	.
300		357,94	603,57	.
⊞								
≤ 50		500	200	200	200	100	50	25
55 - 100		200	100	100	100	50	25	25
110 - 180		.	100	.	50	25	25	10
190 - 260		.	.	.	25	25	10	10
≥ 280		10	10	10

Ref. 0081

+ Medida / Dimensions / Size / Dimensioni / Medida
+ Z



DIN 603+934

BAJA RESISTENCIA
LOW RESISTANCE



TORNILLO CON CUELLO CUADRADO BAJO + TUERCA HEXAGONAL / VIS À MÉTAUX TÊTE FRAISÉE, COLLET CARRÉ AVEC ECROU HEXAGONAUX
COUNTERSUNK HEAD SQUARE NECK BOLT + HEXAGONAL NUT / VITI A TESTA PIANA CON QUADRO SOTTO TESTA CON DADI ESAGONALI
PARAFUSO COM GOLA QUADRADA BAIXO + PORCA HEXAGONAL

Ref. 0080

+ Medida / Dimensions / Size / Dimensioni / Medida
+ B

DIN 608/934



CLASE
CLASSE
CLASS **8.8**



↔	M-10	7/16 (11 mm)	M-12	M-14		
30	92,60	.	122,40	.	Price x 100 units	
35	96,00	108,50	131,50	.		
40	98,90	***	137,70	232,30		
45	109,40	123,80	***	241,40		
50	116,60	131,50	153,10	252,00		
55	.	.	165,60	.		
60	136,90	155,00	176,60	.		
65	.	.	186,70	.		
70	.	174,70	196,30	.		
80	.	193,40	216,50	.		
90	.	213,10	242,90	.		
100	.	236,10	269,80	.		
30-100	100	100	50	50		

TORNILLO CABEZA AVELLANADA CUELLO CUADRADO / BOULON TÊTE FRAISÉE COLLET CARRÉ / COUNTERSUNK SCREW WITH SQUARE NECK
BULLONE TESTA SVASATA COLLO QUADRATO / PARAFUSO DE CABEÇA AVELANADA COM PESCOÇO QUADRADO

Ref. 0085

+ Medida / Dimensions / Size / Dimensioni / Medida
+ P

DIN 608/934



BAJA RESISTENCIA
LOW RESISTANCE



↔	M-8	M-9	M-10	7/16 (11 mm)	M-12	M-14	5/8 (16 mm)	3/4 (19 mm)	
25	31,08	41,50	***	Price x 100 units
30	32,90	***	45,80	***	68,60	.	.	.	
35	34,10	44,70	48,00	58,60	72,50	133,90	.	.	
40	35,20	46,40	49,90	60,50	72,80	139,60	***	.	
45	36,40	48,00	52,30	62,40	79,70	145,90	176,10	.	
50	37,60	49,40	54,20	64,80	83,50	151,60	184,30	***	
55	.	.	***	67,20	86,90	***	***	***	
60	.	.	58,60	69,10	90,70	163,70	201,00	37,05	
65	.	.	.	***	94,10	.	***	.	
70	.	.	64,30	77,30	97,50	173,70	212,60	***	
80	.	.	69,60	85,40	104,10	183,80	***	***	
90	.	.	.	94,10	110,40	194,40	***	44,98	
100	.	.	.	102,20	117,00	***	249,10	.	
25	100	100	100	
30	100	100	50	50	50	.	.	.	
35-65	100	100	100	50	50	50	25	25	
70-100	.	.	50	50	50	25	25	25	

TORNILLO CABEZA AVELLANADA CON PRISIONERO / BOULON TÊTE FRAISÉE AVEC ERGOT / COUNTERSUNK SCREW WITH NIB BULLONE
TESTA SVASATA CON NASELLO / PARAFUSO CABEÇA AVELANADA COM PRISIONEIRO

Ref. 0088

+ Medida / Dimensions / Size / Dimensioni / Medida
+ P



DIN 604/934

CLASE
CLASSE
CLASS **6.8**



↔	M-10	7/16 (11 mm)	M-12	5/8 (16 mm)	3/4 (19 mm)	
30	***	56,50	.	.	.	Price x 100 units
35	***	58,66	72,60	.	.	
40	***	***	76,30	168,00	.	
45	.	.	***	***	.	
50	.	.	***	***	.	
60	.	.	91,10	***	***	
70	.	.	.	***	***	
80	.	.	.	224,30	.	
90	.	.	.	235,90	.	



30-35	100	100	100	.	.
40-45	100	100	50	50	.
50-90	.	.	50	25	25

TORNILLO CABEZA AVELLANADA CON PRISIONERO / BOULON TÊTE FRAISÉE AVEC ERGOT / COUNTERSUNK SCREW WITH NIB BULLONE
TESTA SVASATA CON NASELLO / PARAFUSO CABEÇA AVELANADA COM PRISIONEIRO

Ref. 0089

+ Medida / Dimensions / Size / Dimensioni / Medida

DIN 604/934

CLASE
CLASSE
CLASS **8.8**



↔	M-12	
35	132,00	Price x 100 units
40	138,00	



35	100
40	50

TORNILLO CON CUELLO CUADRADO BAJO + TUERCA HEXAGONAL / VIS À MÉTAUX TÊTE FRAISÉE, COLLET CARRÉ AVEC ECROU HEXAGONAUX
COUNTERSUNK HEAD SQUARE NECK BOLT + HEXAGONAL NUT / VITI A TESTA PIANA CON QUADRO SOTTO TESTA CON DADI ESAGONALI
PARAFUSO COM GOLA QUADRADA BAIXO + PORCA HEXAGONAL

Ref. 0080

+ Medida / Dimensions / Size / Dimensioni / Medida
+ N

DIN 608/934



CLASE
CLASSE
CLASS **8.8**



↔	M	M-10	M-12
30		.	61,30
35		.	63,10
50		35,00	64,50
60		.	68,80
70		.	74,70
80		.	78,20
30-35		100	100
50-60		100	50
70-80		.	50

TORNILLO DOS PRISIONEROS ZINCADO / BOULON DEUX ERGOTS ZINGUÉ / ZINC-PLATED SCREW WITH TWO NIBS
BULLONE DUE NASELLI ZINCATO / PARAFUSO COM DOIS PRISIONEIROZ ZINCADO

Ref. 0091

+ Medida / Dimensions / Size / Dimensioni / Medida
+ Z

CLASE
CLASSE
CLASS **8.8**



↔	M-12	M-14	
35	132,00	214,00	Price x 100 units
40	138,00	233,00	
45	145,00	242,00	
35-45	50	25	

TORNILLO CABEZA CÓNICA / BOULON TÊTE CONIQUE / CLIPPED HEAD SCREW / BULLONE TESTA CONICA / PARAFUSO CABEÇA CÓNICA

Ref. 0092
+ Medida / Dimensions / Size / Dimensioni / Medida

CLASE **12.9/934**
CLASSE
CLASS **10**

↔	M-12	M-14	
33	122,00	232,00	Price x 100 units
37	128,00	237,00	
42	140,00	245,00	
50	.	259,00	
52	165,00	.	
33-52	50	25	



TORNILLO CABEZA COSECHADORA / BOULON TÊTE MOISSONNEUSE-BATTEUSE / BOLT FOR HARVESTER
BULLONE TESTA MIETITREBBIA / PARAFUSO CABEÇA DEBULHADORA

Ref. 0093
+ Medida / Dimensions / Size / Dimensioni / Medida

CLASE **8.8**
CLASSE
CLASS **8 - 934**

↔	M-12	M-14	
33	122,00	232,00	Price x 100 units
37	128,00	237,00	
42	140,00	245,00	
50	.	259,00	
52	165,00	.	
33-52	50	25	



TORNILLO CULTIVADOR / BOULON CULTIVATEUR / FLAT HEAD PLOUGH BOLT / BULLONE COLTIVATORE / PARAFUSO CULTIVADOR

Ref. 0094
+ Medida / Dimensions / Size / Dimensioni / Medida

CLASE **8.8**
CLASSE
CLASS **8 - 934**

↔	M-10	M-12	
36	104,00	.	Price x 100 units
40	115,00	.	
45	129,00	.	
48	.	231,00	
36-48	50	50	



VARILLAS / TIGES FILETÉES / THREADED RODS / VITI SENZA FINE / HASTE

VARILLA ROSCADA 1 METRO ZINCADO / TIGES FILETÉES - 1 METRE ZINGUÉ PLATE / THREADED ROD - 1 METER ZINC PLATED
VITI FILETTATE SENZA TESTA - 1 METRO DI LUNGHEZZA ZINCATE / HASTE ROSCADA 1 METRO ZINCADA

Ref. 0040

+ Medida / Dimensions / Size / Dimensioni / Medida
+ Z

DIN 975

**BAJA RESISTENCIA
LOW RESISTANCE**



ROSCA MÉTRICA / FILETAGE MÉTRIQUE
METRIC THREAD / FILETTATURA METRICA
ROSCA MÉTRICA

Ref	M			
0040 0003Z	M-3	0,50	100	0,55
0040 0004Z	M-4	0,70	100	0,68
0040 0005Z	M-5	0,80	100	0,95
0040 0006Z	M-6	1,00	100	1,10
0040 0007Z	M-7	1,00	50	2,46
0040 0008Z	M-8	1,25	50	2,80
0040 0010Z	M-10	1,50	25	3,20
0040 0012Z	M-12	1,75	20	3,55
0040 0014Z	M-14	2,00	10	4,11
0040 0016Z	M-16	2,00	10	5,72
0040 0018Z	M-18	2,50	10	7,21
0040 0020Z	M-20	2,50	5	9,59
0040 0022Z	M-22	2,50	5	12,10
0040 0024Z	M-24	3,00	5	14,20
0040 0027Z	M-27	3,00	5	21,80
0040 0030Z	M-30	3,50	3	30,20
0040 0033Z	M-33	3,50	3	37,70
0040 0036Z	M-36	4,00	3	39,20
0040 0039Z	M-39	4,00	3	50,90
0040 0042Z	M-42	4,50	1	57,80
0040 0045Z	M-45	4,50	1	75,10
0040 0048Z	M-48	5,00	1	77,20
0040 0052Z	M-52	5,00	1	92,21

ROSCA MÉTRICA / FILETAGE MÉTRIQUE
METRIC THREAD / FILETTATURA METRICA
ROSCA MÉTRICA

Ref	M			
0040 0003Z-U	M-3	0,50	1	0,63
0040 0004Z-U	M-4	0,70	1	0,71
0040 0005Z-U	M-5	0,80	1	1,05
0040 0006Z-U	M-6	1,00	1	1,20
0040 0007Z-U	M-7	1,00	1	2,83
0040 0008Z-U	M-8	1,25	1	3,12
0040 0010Z-U	M-10	1,50	1	3,35
0040 0012Z-U	M-12	1,75	1	3,52
0040 0014Z-U	M-14	2,00	1	4,73
0040 0016Z-U	M-16	2,00	1	6,58
0040 0018Z-U	M-18	2,50	1	8,28
0040 0020Z-U	M-20	2,50	1	11,02
0040 0022Z-U	M-22	2,50	1	13,79
0040 0024Z-U	M-24	3,00	1	16,10
0040 0027Z-U	M-27	3,00	1	24,28
0040 0030Z-U	M-30	3,50	1	33,45
0040 0033Z-U	M-33	3,50	1	42,11
0040 0036Z-U	M-36	4,00	1	44,41
0040 0039Z-U	M-39	4,00	1	57,27

VARILLA ROSCADA 2 METROS ZINCADO / TIGES FILETÉES - 2 METRES ZINGUÉ PLATE / THREADED ROD - 2 METERS ZINC PLATED
VITI FILETTATE SENZA TESTA - 2 METRI DI LUNGHEZZA ZINCATE / HASTE ROSCADA 2 METRO ZINCADA

Ref. 0040 20

+ Medida / Dimensions / Size / Dimensioni / Medida
+ Z

DIN 975

**BAJA RESISTENCIA
LOW RESISTANCE**



ROSCA MÉTRICA / FILETAGE MÉTRIQUE
METRIC THREAD / FILETTATURA METRICA
ROSCA MÉTRICA

Ref	M			
0040 2006Z	M-6	1,00	50	2,52
0040 2008Z	M-8	1,25	25	4,28
0040 2010Z	M-10	1,50	20	6,72
0040 2012Z	M-12	1,75	10	10,03
0040 2014Z	M-14	2,00	10	13,92
0040 2016Z	M-16	2,00	5	18,54
0040 2020Z	M-20	2,50	5	24,15



VARILLA ROSCADA PAVONADA 1 METRO NEGRO / TIGES FILETÉES - 1 METRE NOIR / THREADED ROD - 1 METER LONG BLACK
VITI FILETTATE SENZA TESTA, NERE - 1 METRO DI LUNGHEZZA / HASTE ROSCADA POLIDA 1 METRO PRETO

Ref. 0067

+ Medida / Dimensions / Size / Dimensioni / Medida



DIN 975



**CLASE
CLASSE
CLASS 8.8**

ROSCA MÉTRICA / FILETAGE MÉTRIQUE
METRIC THREAD / FILETTATURA METRICA
ROSCA MÉTRICA

Ref	M	🌀	📦	📏
0067 0005	M-5	0,80	50	1,29
0067 0006	M-6	1,00	50	2,04
0067 0008	M-8	1,25	50	3,23
0067 0010	M-10	1,50	25	4,31
0067 0012	M-12	1,75	20	6,55
0067 0014	M-14	2,00	10	8,70
0067 0016	M-16	2,00	10	10,06
0067 0018	M-18	2,50	10	14,40
0067 0020	M-20	2,50	5	18,06
0067 0022	M-22	2,50	5	20,95
0067 0024	M-24	3,00	5	27,70
0067 0027	M-27	3,00	5	34,52
0067 0030	M-30	3,50	3	44,41

ROSCA MÉTRICA / FILETAGE MÉTRIQUE
METRIC THREAD / FILETTATURA METRICA
ROSCA MÉTRICA

Ref	M	🌀	📦	📏
0067 0005-U	M-5	0,80	1	1,55
0067 0006-U	M-6	1,00	1	2,33
0067 0008-U	M-8	1,25	1	3,72
0067 0010-U	M-10	1,50	1	4,95
0067 0012-U	M-12	1,75	1	7,52
0067 0014-U	M-14	2,00	1	10,40
0067 0016-U	M-16	2,00	1	12,05
0067 0018-U	M-18	2,50	1	17,28
0067 0020-U	M-20	2,50	1	21,67
0067 0022-U	M-22	2,50	1	25,14
0067 0024-U	M-24	3,00	1	33,24
0067 0027-U	M-27	3,00	1	39,69
0067 0030-U	M-30	3,50	1	51,06



VARILLA ROSCADA 1 METRO ZINCADA / TIGES FILETÉES - 1 METRE ZINGUÉ / THREADED ROD - 1 METER LONG ZINC
VITI FILETTATE SENZA TESTA, ZINCATE - 1 METRO DI LUNGHEZZA / HASTE ROSCADA 1 METRO ZINCADA

Ref. 0067

+ Medida / Dimensions / Size / Dimensioni / Medida
+ Z



DIN 975



**CLASE
CLASSE
CLASS 8.8**

ROSCA MÉTRICA / FILETAGE MÉTRIQUE
METRIC THREAD / FILETTATURA METRICA
ROSCA MÉTRICA

Ref	M	🌀	📦	📏
0067 0005Z	M-5	0,80	50	1,75
0067 0006Z	M-6	1,00	50	2,09
0067 0008Z	M-8	1,25	50	3,25
0067 0010Z	M-10	1,50	25	4,35
0067 0012Z	M-12	1,75	20	7,01
0067 0014Z	M-14	2,00	10	9,38
0067 0016Z	M-16	2,00	10	11,82
0067 0018Z	M-18	2,50	10	15,56
0067 0020Z	M-20	2,50	5	18,58
0067 0022Z	M-22	2,50	5	23,65
0067 0024Z	M-24	3,00	5	28,80
0067 0027Z	M-27	3,00	5	37,30
0067 0030Z	M-30	3,50	5	48,25

ROSCA MÉTRICA / FILETAGE MÉTRIQUE
METRIC THREAD / FILETTATURA METRICA
ROSCA MÉTRICA

Ref	M	🌀	📦	📏
0067 0005Z-U	M-5	0,80	1	2,10
0067 0006Z-U	M-6	1,00	1	2,40
0067 0008Z-U	M-8	1,25	1	3,73
0067 0010Z-U	M-10	1,50	1	4,99
0067 0012Z-U	M-12	1,75	1	8,40
0067 0014Z-U	M-14	2,00	1	11,25
0067 0016Z-U	M-16	2,00	1	14,18
0067 0018Z-U	M-18	2,50	1	18,67
0067 0020Z-U	M-20	2,50	1	22,30
0067 0022Z-U	M-22	2,50	1	28,38
0067 0024Z-U	M-24	3,00	1	34,56
0067 0027Z-U	M-27	3,00	1	42,08
0067 0030Z-U	M-30	3,50	1	57,90



VARILLAS / TIGES FILETÉES / THREADED RODS / VITI SENZA FINE / HASTE

VARILLA ROSCADA 1 METRO ZINCADO / TIGES FILETÉES - 1 METRE ZINGUÉ PLATE / THREADED ROD - 1 METER ZINC PLATED
VITI FILETTATE SENZA TESTA - 1 METRO DI LUNGHEZZA ZINCATE / HASTE ROSCADA 1 METRO ZINCADA

WHITWORTH

Ref. 0040



+ Medida / Dimensions / Size / Dimensioni / Medida
+ Z

DIN 975

1 m

ZINC
PLATEDBAJA RESISTENCIA
LOW RESISTANCE

ROSCA MÉTRICA / FILETAGE MÉTRIQUE
METRIC THREAD / FILETTATURA METRICA
ROSCA MÉTRICA

Ref	M			
0040 0108Z	1/8	40h	200	1,72
0040 0532Z	5/32	32h	200	1,90
0040 0316Z	3/16	24h	100	2,04
0040 0104Z	1/4	20h	100	2,87
0040 0516Z	5/16	18h	50	4,06
0040 0308Z	3/8	16h	50	5,94
0040 0716Z	7/16	14h	25	8,02
0040 0102Z	1/2	12h	25	9,70
0040 0916Z	9/16	12h	20	13,37
0040 0508Z	5/8	11h	15	14,85
0040 0304Z	3/4	10h	10	22,28
0040 0708Z	7/8	9h	10	32,18
0040 0100Z	1"	8h	8	40,59
0040 0118Z	1" 1/8	7h	1	59,40
0040 0114Z	1" 1/4	7h	1	76,73
0040 0138Z	1" 3/8	6h	1	118,80
0040 0112Z	1" 1/2	6h	1	126,23
0040 0134Z	1" 3/4	5h	1	227,70
0040 0200Z	2"	4,5h	1	430,65

VARILLA ROSCA IZQUIERDA 1 METRO ZINCADO / TIGES FILETÉES PAS À GAUCHE - LONGUEUR 1 MÈTRE ZINGUÉ
THREADED ROD LEFT HAND THREAD - 1 METER LONG ZINC PLATED / VITI SENZA TESTA, FILETTO SINISTRO - 1 METRO DI LUNGHEZZA ZINCATE
HASTE ROSCADA ESQUERDAS 1 METRO ZINCADA

WHITWORTH

Ref. 0040

+ Medida / Dimensions / Size / Dimensioni / Medida
+ I



DIN 975

1 m

ZINC
PLATEDBAJA RESISTENCIA
LOW RESISTANCE

ROSCA IZQUIERDAS
A GAUCHE
LEFT HAND
SINISTRO
ESQUERDAS

ROSCA MÉTRICA / FILETAGE MÉTRIQUE
METRIC THREAD / FILETTATURA METRICA
ROSCA MÉTRICA

Ref	M			
0040 0508 I	5/8	11h	15	22,28
0040 0304 I	3/4	10h	10	33,41
0040 0708 I	7/8	9h	10	68,64
0040 0100 I	1"	8h	8	74,25
0040 0118 I	1" 1/8	7h	1	89,10
0040 0114 I	1" 1/4	7h	1	138,60
0040 0138 I	1" 3/8	6h	1	178,20
0040 0112 I	1" 1/2	6h	1	189,33



ESPÁRRAGO ROSCADO ALLEN PUNTA PLANA NEGRO / VIS SANS TÊTE À 6 PANS CREUX NOIR
HEXAGON SOCKET HEADLESS SETS CREW WITH FLAT POINT BLACK / VITI NERE SENZA TESTA CON FILETTATURA ALLEN E PUNTA PIATTA
PARAFUSO PRISIONEIRO ALLEN. PUNTA PLANA, PRETO

Ref	M			
0083 0303	3 x 3	200	7,67	
0083 0304	3 x 4	200	7,73	
0083 0305	3 x 5	200	7,79	
0083 0306	3 x 6	200	8,04	
0083 0308	3 x 8	200	8,31	
0083 0310	3 x 10	200	9,32	
0083 0312	3 x 12	200	10,47	
0083 0316	3 x 16	200	15,06	
0083 0320	3 x 20	200	17,37	
0083 0406	4 x 6	200	7,28	
0083 0408	4 x 8	200	7,40	
0083 0410	4 x 10	200	7,54	
0083 0412	4 x 12	200	7,79	
0083 0416	4 x 16	200	9,06	
0083 0420	4 x 20	200	12,25	
0083 0425	4 x 25	200	13,81	
0083 0430	4 x 30	200	21,85	
0083 0506	5 x 6	200	7,54	
0083 0508	5 x 8	200	7,79	
0083 0510	5 x 10	200	8,04	
0083 0512	5 x 12	200	8,54	
0083 0516	5 x 16	200	10,22	
0083 0520	5 x 20	200	13,53	
0083 0525	5 x 25	200	18,65	
0083 0530	5 x 30	200	22,21	
0083 0535	5 x 35	200	28,35	
0083 0540	5 x 40	200	30,77	
0083 0606	6 x 6	200	8,31	
0083 0608	6 x 8	200	8,42	
0083 0610	6 x 10	200	8,56	
0083 0612	6 x 12	200	8,94	
0083 0614	6 x 14	200	10,47	
0083 0616	6 x 16	200	11,20	
0083 0620	6 x 20	200	13,92	
0083 0625	6 x 25	200	18,90	
0083 0630	6 x 30	200	24,64	
0083 0635	6 x 35	200	28,60	
0083 0640	6 x 40	200	30,77	
0083 0645	6 x 45	200	34,09	
0083 0650	6 x 50	200	38,82	
0083 0660	6 x 60	200	61,55	
0083 0808	8 x 8	200	10,85	
0083 0810	8 x 10	200	11,36	
0083 0812	8 x 12	200	12,25	
0083 0814	8 x 14	200	16,60	
0083 0816	8 x 16	200	17,36	
0083 0820	8 x 20	200	18,90	
0083 0825	8 x 25	200	24,64	
0083 0830	8 x 30	200	29,37	
0083 0835	8 x 35	200	34,09	
0083 0840	8 x 40	200	38,82	
0083 0845	8 x 45	200	58,41	
0083 0850	8 x 50	200	64,46	
0083 0860	8 x 60	200	99,00	
0083 0870	8 x 70	100	141,70	
0083 0880	8 x 80	100	236,23	

Price
x 100
units

Ref	M			
0083 1008	10 x 8	200	17,55	
0083 1010	10 x 10	200	18,90	
0083 10100	10 x 100	50	365,90	
0083 1012	10 x 12	200	19,66	
0083 1014	10 x 14	200	21,50	
0083 1016	10 x 16	200	26,64	
0083 1020	10 x 20	200	27,85	
0083 1025	10 x 25	200	35,50	
0083 1030	10 x 30	200	41,46	
0083 1035	10 x 35	100	47,37	
0083 1040	10 x 40	100	54,38	
0083 1045	10 x 45	100	66,40	
0083 1050	10 x 50	100	75,34	
0083 1060	10 x 60	50	164,71	
0083 1070	10 x 70	50	179,88	
0083 1080	10 x 80	50	194,79	
0083 1090	10 x 90	50	310,20	
0083 1210	12 x 10	200	31,65	
0083 12100	12 x 100	25	435,60	
0083 1212	12 x 12	200	33,20	
0083 1220	12 x 20	200	43,53	
0083 1225	12 x 25	100	49,68	
0083 1230	12 x 30	100	59,11	
0083 1235	12 x 35	100	71,50	
0083 1240	12 x 40	100	77,89	
0083 1245	12 x 45	50	91,93	
0083 1250	12 x 50	50	97,02	
0083 1260	12 x 60	50	141,70	
0083 1270	12 x 70	50	173,64	
0083 1280	12 x 80	25	244,23	
0083 14100	14 x 100	25	568,15	
0083 1420	14 x 20	100	117,69	
0083 1430	14 x 30	100	190,91	
0083 1435	14 x 35	100	210,52	
0083 1440	14 x 40	50	214,65	
0083 1445	14 x 45	50	218,41	
0083 1450	14 x 50	50	228,46	
0083 1460	14 x 60	25	290,84	
0083 1470	14 x 70	25	357,84	
0083 1480	14 x 80	25	469,92	
0083 1490	14 x 90	25	557,37	
0083 1625	16 x 25	100	127,09	
0083 1630	16 x 30	50	141,17	
0083 1635	16 x 35	50	154,87	
0083 1640	16 x 40	50	167,54	
0083 1645	16 x 45	50	184,67	
0083 1650	16 x 50	50	249,69	
0083 1660	16 x 60	25	254,19	
0083 1670	16 x 70	25	272,31	
0083 1680	16 x 80	25	388,16	
0083 1690	16 x 90	25	506,94	
0083 16100	16 x 100	25	629,32	

Price
x 100
units

Ref. 0083

+ Medida / Dimensions / Size / Dimensioni / Medida



DIN 913

CLASE
CLASSE
CLASS **45H**



MALETÍN SURTIDO ESPÁRRAGOS DIN-913 C-45H / VALISE ASSORTIMENT VIS SANS TÊTE DIN-913 C-45H
BOX OF SOCKET HEADLESS SET SCREWS DIN-913 C-45H / VALIGETTA ASSORTITA VITI SENZA TESTA, DIN-913 C-45H
MALETA DE PARAFUSOS PRISIONEIRO SORTIDOS DIN-913 C-45H

DIN 913



Ref		
0401 0083	885 pcs	180,10

CONTENIDO / CONTENU / CONTAINS
CONTENUTO / CONTEÚDO

Ref		
0083 0312	DIN-913 C-45H M-3 x 12 N	100
0083 0406	DIN-913 C-45H M-4 x 6 N	100
0083 0410	DIN-913 C-45H M-4 x 10 N	100
0083 0420	DIN-913 C-45H M-4 x 20 N	40
0083 0506	DIN-913 C-45H M-5 x 6 N	100
0083 0510	DIN-913 C-45H M-5 x 10 N	40
0083 0516	DIN-913 C-45H M-5 x 16 N	40
0083 0606	DIN-913 C-45H M-6 x 6 N	100
0083 0610	DIN-913 C-45H M-6 x 10 N	40
0083 0616	DIN-913 C-45H M-6 x 16 N	40
0083 0816	DIN-913 C-45H M-8 x 16 N	40
0083 0830	DIN-913 C-45H M-8 x 30 N	20
0083 0840	DIN-913 C-45H M-8 x 40 N	20
0083 1010	DIN-913 C-45H M-10 x 10 N	40
0083 1040	DIN-913 C-45H M-10 x 40 N	20
0083 1240	DIN-913 C-45H M-12 x 40 N	20
0083 1420	DIN-913 C-45H M-14 x 20 N	20
0083 1660	DIN-913 C-45H M-16 x 60 N	5
0940 0223	Box of 22 sections 364 x 268 x 66 mm	1

ESPÁRRAGO ROSCADO ALLEN PUNTA CÓNICA NEGRO / VIS SANS TÊTE À 6 PANS CREUX NOIR
HEXAGON SOCKET HEADLESS SETS CREW WITH CONE POINT BLACK / VITI NERE SENZA TESTA CON PUNTA CONICA
PARAFUSO PRISIONEIRO ALLEN PUNTA CÔNICA PRETO

Ref	M		
0084 0304	3 x 4	200	15,44
0084 0305	3 x 5	200	15,80
0084 0306	3 x 6	200	16,08
0084 0308	3 x 8	200	16,72
0084 0310	3 x 10	200	17,37
0084 0312	3 x 12	200	21,85
0084 0404	4 x 4	200	8,31
0084 0405	4 x 5	200	8,51
0084 0406	4 x 6	200	8,80
0084 0408	4 x 8	200	9,00
0084 0410	4 x 10	200	9,74
0084 0412	4 x 12	200	12,27
0084 0416	4 x 16	200	15,16
0084 0505	5 x 5	200	9,00
0084 0506	5 x 6	200	9,10
0084 0508	5 x 8	200	9,20
0084 0510	5 x 10	200	9,24
0084 0512	5 x 12	200	9,97
0084 0516	5 x 16	200	12,05
0084 0520	5 x 20	200	20,42
0084 0606	6 x 6	200	11,87
0084 0608	6 x 8	200	12,25
0084 0610	6 x 10	200	12,55
0084 0612	6 x 12	200	12,85
0084 0616	6 x 16	200	13,20
0084 0620	6 x 20	200	16,07
0084 0625	6 x 25	200	21,85
0084 0808	8 x 8	200	17,69
0084 0810	8 x 10	200	18,60
0084 0812	8 x 12	200	19,45
0084 0816	8 x 16	200	20,83
0084 0820	8 x 20	200	21,32
0084 0825	8 x 25	200	33,20
0084 0830	8 x 30	200	42,65

Price
x 100
units

Ref	M		
0084 1010	10 x 10	200	33,92
0084 1012	10 x 12	200	35,50
0084 1016	10 x 16	200	37,65
0084 1020	10 x 20	200	40,95
0084 1025	10 x 25	200	44,61
0084 1030	10 x 30	100	59,61
0084 1035	10 x 35	100	81,42
0084 1212	12 x 12	200	57,16
0084 1216	12 x 16	200	61,35
0084 1220	12 x 20	200	66,40
0084 1225	12 x 25	100	77,07
0084 1230	12 x 30	100	86,03
0084 1235	12 x 35	100	101,24
0084 1240	12 x 40	100	114,58
0084 1250	12 x 50	50	144,28
0084 1420	14 x 20	100	207,64
0084 1430	14 x 30	100	251,99
0084 1435	14 x 35	100	276,28
0084 1440	14 x 40	50	298,06
0084 1450	14 x 50	50	424,12
0084 1616	16 x 16	100	164,54
0084 1620	16 x 20	100	172,99
0084 1625	16 x 25	100	190,48
0084 1630	16 x 30	50	207,64
0084 1635	16 x 35	50	226,84
0084 1640	16 x 40	50	244,73
0084 1650	16 x 50	50	317,46
0084 1660	16 x 60	25	360,94

Price
x 100
units

Ref. 0084

+ Medida / Dimensions / Size / Dimensioni / Medida



DIN 914

CLASE
CLASSE
CLASS **45H**



MALETÍN SURTIDO ESPÁRRAGOS DIN-914 C-45H / VALISE ASSORTIMENT VIS SANS TÊTE DIN-914 C-45H
BOX OF SOCKET HEADLESS SET SCREWS DIN-914 C-45H / VALIGETTA ASSORTITA VITI SENZA TESTA, DIN-914 C-45H
MALETA DE PARAFUSOS PRISIONEIRO SORTIDOS DIN-914 C-45H

CONTENIDO / CONTENU / CONTAINS
CONTENUTO / CONTEÚDO

DIN 914

Ref		
0401 0084	885 pcs	251,60

Ref		
0084 0312	DIN-914 C-45H M-3 x 12 N	100
0084 0406	DIN-914 C-45H M-4 x 6 N	100
0084 0410	DIN-914 C-45H M-4 x 10 N	100
0084 0416	DIN-914 C-45H M-4 x 16 N	40
0084 0506	DIN-914 C-45H M-5 x 6 N	100
0084 0510	DIN-914 C-45H M-5 x 10 N	40
0084 0516	DIN-914 C-45H M-5 x 16 N	40
0084 0606	DIN-914 C-45H M-6 x 6 N	100
0084 0610	DIN-914 C-45H M-6 x 10 N	40
0084 0616	DIN-914 C-45H M-6 x 16 N	40
0084 0816	DIN-914 C-45H M-8 x 16 N	40
0084 0825	DIN-914 C-45H M-8 x 25 N	20
0084 0830	DIN-914 C-45H M-8 x 30 N	20
0084 1010	DIN-914 C-45H M-10 x 10 N	40
0084 1030	DIN-914 C-45H M-10 x 30 N	20
0084 1240	DIN-914 C-45H M-12 x 40 N	20
0084 1420	DIN-914 C-45H M-14 x 20 N	20
0084 1660	DIN-914 C-45H M-16 x 60 N	5
0940 0223	Box of 22 sections 364 x 268 x 66 mm	1



TUERCA HEXAGONAL / ECROUS HEXAGONAUX / HEXAGON NUT / DADI ESAGONALI / PORCA HEXAGONAL

Ref. 0032

+ Medida / Dimensions / Size / Dimensioni / Medida

DIN 934

CLASE
CLASSE
CLASS 8Rosca métrica ISO paso normal
Filetage métrique ISO à pas gros
ISO metric thread coarse pitch
Filettatura metrica ISO a passo grosso
Rosca métrica ISO passo normal

Ref	M			
0032 0003	M-3	500	0,70	
0032 0004	M-4	500	1,06	
0032 0005	M-5	500	1,26	
0032 0006	M-6	500	1,82	
0032 0007	M-7	500	3,08	
0032 0008	M-8	500	4,34	
0032 0010	M-10	300	10,02	
0032 0012	M-12	200	15,83	
0032 0014	M-14	100	20,37	
0032 0016	M-16	100	28,38	
0032 0018	M-18	100	43,26	
0032 0020	M-20	50	61,73	
0032 0022	M-22	50	72,80	
0032 0024	M-24	25	91,90	
0032 0027	M-27	25	153,13	
0032 0030	M-30	25	218,12	
0032 0033	M-33	10	315,04	

Price
x 100
units

Ref. 0032

+ Medida / Dimensions / Size / Dimensioni / Medida

+N

DIN 934

CLASE
CLASSE
CLASS 8Rosca métrica ISO paso normal
Filetage métrique ISO à pas gros
ISO metric thread coarse pitch
Filettatura metrica ISO a passo grosso
Rosca métrica ISO passo normal

Ref	M			
0032 0003N	M-3	500	0,83	
0032 0004N	M-4	500	1,19	
0032 0005N	M-5	500	1,33	
0032 0006N	M-6	500	2,10	
0032 0007N	M-7	500	3,92	
0032 0008N	M-8	500	4,83	
0032 0010N	M-10	300	10,15	
0032 0012N	M-12	200	13,72	
0032 0014N	M-14	100	20,02	
0032 0016N	M-16	100	28,36	
0032 0018N	M-18	100	44,17	
0032 0020N	M-20	50	54,01	
0032 0022N	M-22	50	71,39	
0032 0024N	M-24	25	109,58	
0032 0027N	M-27	25	185,58	
0032 0030N	M-30	25	264,17	
0032 0033N	M-33	10	385,15	
0032 0036N	M-36	10	493,72	
0032 0039N	M-39	10	631,71	
0032 0042N	M-42	5	801,26	
0032 0045N	M-45	5	970,35	
0032 0048N	M-48	5	1501,40	
0032 0052N	M-52	5	1734,50	

Price
x 100
units

TUERCA HEXAGONAL · PASO FINO / ECROUS HEXAGONAUX · PAS FIN / HEXAGON NUT · FINE PITCH
DADI ESAGONALI · PASSO FINE / PORCA HEXAGONAL · PASSOS FINOS

Rosca métrica ISO paso fino
Filetage métrique ISO à pas fin
ISO metric thread fine pitch
Filettatura metrica ISO a passo fine
Rosca métrica ISO passo fino

Ref. 0032
+ Medida / Dimensions / Size / Dimensioni / Medida



DIN 934

CLASE
CLASSE
CLASS **8**

Ref	M			
0032 08100N	M-8 x 1,00	200	13,21	
0032 10100N	M-10 x 1,00	200	27,45	
0032 10125N	M-10 x 1,25	100	29,35	
0032 12125N	M-12 x 1,25	100	36,33	
0032 12150N	M-12 x 1,50	100	37,39	
0032 14150N	M-14 x 1,50	100	55,90	
0032 16150N	M-16 x 1,50	50	73,69	Price x 100 units
0032 18150N	M-18 x 1,50	50	155,00	
0032 20150N	M-20 x 1,50	25	203,28	
0032 22150N	M-22 x 1,50	10	261,72	
0032 24150N	M-24 x 1,50	10	353,20	
0032 24200N	M-24 x 2,00	10	360,82	
0032 27150N	M-27 x 1,50	5	759,00	
0032 27200N	M-27 x 2,00	5	775,00	
0032 30200N	M-30 x 2,00	5	810,00	



TUERCA HEXAGONAL / ECROUS HEXAGONAUX / HEXAGON NUT / DADI ESAGONALI / PORCA HEXAGONAL

Rosca métrica ISO paso normal
Filetage métrique ISO à pas gros
ISO metric thread coarse pitch
Filettatura metrica ISO a passo grosso
Rosca métrica ISO passo normal

Rosca métrica ISO paso fino
Filetage métrique ISO à pas fin
ISO metric thread fine pitch
Filettatura metrica ISO a passo fine
Rosca métrica ISO passo fino

Ref. 0035
+ Medida / Dimensions / Size / Dimensioni / Medida



DIN 934

CLASE
CLASSE
CLASS **10**

Ref	M			
0035 0006	M-6	500	2,80	
0035 0008	M-8	200	5,28	
0035 0010	M-10	200	11,29	
0035 0012	M-12	100	18,82	
0035 0014	M-14	100	23,30	
0035 0016	M-16	50	30,60	Price x 100 units
0035 0018	M-18	50	37,65	
0035 0020	M-20	50	60,10	
0035 0022	M-22	25	75,90	
0035 0024	M-24	25	114,35	
0035 0027	M-27	25	177,41	
0035 0030	M-30	10	240,24	

Ref	M			
0035 08100	M-8 x 1,00	100	19,06	
0035 10100	M-10 x 1,00	100	36,97	
0035 10125	M-10 x 1,25	100	39,65	
0035 12125	M-12 x 1,25	100	49,06	
0035 12150	M-12 x 1,50	100	53,54	Price x 100 units
0035 14150	M-14 x 1,50	50	72,53	
0035 16150	M-16 x 1,50	50	101,73	
0035 18150	M-18 x 1,50	50	168,91	
0035 20150	M-20 x 1,50	25	235,61	



TUERCA HEXAGONAL NEGRO / ECROUS HEXAGONAUX NOIR / HEXAGON NUT BLACK / DADI ESAGONALI NERI / PORCA HEXAGONAL PRETA

WHITWORTH

Ref. 0046

+ Medida / Dimensions / Size / Dimensioni / Medida

DIN 934

BAJA RESISTENCIA
LOW RESISTANCE

Ref	M				
0046 0018	1/8"	40h	250	1,40	
0046 0532	5/32"	32h	250	1,63	
0046 0316	3/16"	24h	250	2,38	
0046 0014	1/4"	20h	100	4,95	
0046 0516	5/16"	18h	100	8,04	
0046 0038	3/8"	16h	100	14,20	
0046 0716	7/16"	14h	50	20,32	
0046 0012	1/2"	12h	50	34,38	
0046 0916	9/16"	12h	50	40,40	
0046 0058	5/8"	11h	25	51,83	Price
0046 0034	3/4"	10h	10	102,71	x 100
0046 0078	7/8"	9h	10	155,82	units
0046 0001	1"	8h	5	210,40	
0046 0118	1 1/8	7h	1	416,25	
0046 0114	1 1/4	7h	1	533,61	
0046 0138	1 3/8	6h	1	862,41	
0046 0112	1 1/2	6h	1	913,11	
0046 0134	1 3/4	5h	1	1674,06	
0046 0002	2"	4,5h	1	3043,78	

TUERCA HEXAGONAL NEGRO / ECROUS HEXAGONAUX NOIR / HEXAGON NUT BLACK / DADI ESAGONALI NERI / PORCA HEXAGONAL PRETA

WHITWORTH

Ref. 0038

+ Medida / Dimensions / Size / Dimensioni / Medida

DIN 934

CLASE
CLASSE
CLASS 8

Ref	M				
0038 0014	1/4	20 h	100	18,15	
0038 0516	5/16	18 h	100	20,35	
0038 0038	3/8	16 h	50	33,99	
0038 0716	7/16	14 h	50	37,13	
0038 0012UNC	1/2 UNC	13 h	25	55,68	Price
0038 0012	1/2	12 h	25	55,68	x 100
0038 0916	9/16	12 h	25	77,34	units
0038 0058	5/8	11 h	10	115,50	
0038 0034	3/4	10 h	5	278,43	
0038 0078	7/8	9 h	5	356,40	
0038 0001	1	8 h	5	521,98	

TUERCA PASO IZQUIERDAS PULIDO / ECROUS HEXAGONAUX PAS A GAUCHE POLIE / HEXAGON NUT LEFT HAND THREAD POLISHED
DADI ESAGONALI LUCIDATO FILETTO SINISTRO / ROSCAS ESQUERDAS PRETAS POLIDO

WHITWORTH

Ref. 0038

+ Medida / Dimensions / Size / Dimensioni / Medida + I



DIN 934

CLASE
CLASSE
CLASS 8



ROSCA IZQUIERDAS / A GAUCHE / LEFT HAND SINISTRO / ESQUERDAS

Ref	M				
0038 0058 I	5/8"	11h	5	935,77	
0038 0034 I	3/4"	10h	5	1542,48	
0038 0078 I	7/8"	9h	5	1612,60	
0038 0001 I	1"	8h	1	1716,55	
0038 0118 I	1" 1/8	7h	1	2034,41	Price x 100 units
0038 0114 I	1" 1/4	7h	1	2036,54	
0038 0138 I	1" 3/8	6h	1	2638,48	
0038 0112 I	1" 1/2	6h	1	3024,85	
0038 0002 I	2"	4,5h	1	3240,79	

TUERCA HEXAGONAL NEGRO / ECROUS HEXAGONAUX NOIR / HEXAGON NUT BLACK
DADI ESAGONALI NERI / PORCA HEXAGONAL PRETA

UNF / UNS (SAE)

Ref. 0039

+ Medida / Dimensions / Size / Dimensioni / Medida



DIN 934

CLASE
CLASSE
CLASS 8



Ref	M				
0039 0014	1/4	28 h	100	19,80	
0039 0516	5/16	24 h	100	27,72	
0039 0038	3/8	24 h	50	42,90	
0039 0716	7/16	20 h	50	56,10	
0039 0012	1/2	20 h	25	79,20	Price x 100 units
0039 0916	9/16	18 h	25	105,60	
0039 0058	5/8	18 h	10	141,90	
0039 0034	3/4	16 h	5	306,90	
0039 0078	7/8	14 h	5	412,50	
0039 0001	1"	12h	5	834,90	

TUERCA HEXAGONAL AUTOBLOCANTE NYLON ZINCADO / ECROUS HEXAGONAUX INDESSERABLES AVEC BAGUE NYLON ZINGUÉ
 HEXAGON LOCKNUT WITH NYLON INSERT ZINC PLATED / DADI ZINCATI ESAGONALI CON INSERTO IN NYLON, AUTOFRENANTI
 PORCA HEXAGONAL AUTO-BLOQUEANTE NYLON ZINCADO

Ref. 0037

+ Medida / Dimensions / Size / Dimensioni / Medida

DIN 985



CLASE
CLASSE
CLASS **8**

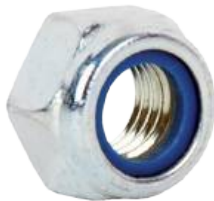

Rosca métrica ISO paso normal
 Filetage métrique ISO à pas gros
 ISO metric thread coarse pitch
 Filettatura metrica ISO a passo grosso
 Rosca métrica ISO passo normal

Rosca métrica ISO paso fino
 Filetage métrique ISO à pas fin
 ISO metric thread fine pitch
 Filettatura metrica ISO a passo fine
 Rosca métrica ISO passo fino

Ref	M			
0037 0003	M-3	500	1,85	
0037 0004	M-4	500	1,90	
0037 0005	M-5	500	1,95	
0037 0006	M-6	500	2,34	
0037 0007	M-7	500	4,77	
0037 0008	M-8	500	5,25	
0037 0010	M-10	200	10,43	
0037 0012	M-12	200	15,80	
0037 0014	M-14	100	23,65	
0037 0016	M-16	100	31,90	
0037 0018	M-18	50	51,50	
0037 0020	M-20	50	61,60	
0037 0022	M-22	25	97,98	
0037 0024	M-24	25	120,52	
0037 0027	M-27	15	234,90	
0037 0030	M-30	15	394,48	

Price
x 100
units

Ref	M			
0037 08100	M-8 x 1,00	200	12,96	
0037 10100	M-10 x 1,00	200	26,42	
0037 10125	M-10 x 1,25	200	27,30	
0037 12125	M-12 x 1,25	100	29,10	
0037 12150	M-12 x 1,50	100	38,12	
0037 14150	M-14 x 1,50	100	63,53	
0037 16150	M-16 x 1,50	100	76,23	
0037 18150	M-18 x 1,50	50	132,13	
0037 20150	M-20 x 1,50	50	165,17	
0037 22150	M-22 x 1,50	10	411,64	
0037 24150	M-24 x 1,50	10	596,20	
0037 24200	M-24 x 2,00	10	606,38	
0037 27200	M-27 x 2,00	5	1207,26	
0037 30200	M-30 x 2,00	5	1329,63	

Price
x 100
units

TUERCA HEXAGONAL AUTOBLOCANTE NYLON ZINCADO / ECROUS HEXAGONAUX INDESSERABLES AVEC BAGUE NYLON ZINGUÉ
 HEXAGON LOCKNUT WITH NYLON INSERT ZINC PLATED / DADI ZINCATI ESAGONALI CON INSERTO IN NYLON, AUTOFRENANTI
 PORCA HEXAGONAL AUTO-BLOQUEANTE NYLON ZINCADO

Ref. 0049

+ Medida / Dimensions / Size / Dimensioni / Medida

DIN 985



CLASE
CLASSE
CLASS **10**



Rosca métrica ISO paso normal
 Filetage métrique ISO à pas gros
 ISO metric thread coarse pitch
 Filettatura metrica ISO a passo grosso
 Rosca métrica ISO passo normal

Rosca métrica ISO paso fino
 Filetage métrique ISO à pas fin
 ISO metric thread fine pitch
 Filettatura metrica ISO a passo fine
 Rosca métrica ISO passo fino

Ref	M			
0049 0006	M-6	100	7,50	
0049 0008	M-8	100	10,33	
0049 0010	M-10	50	22,88	
0049 0012	M-12	50	32,77	
0049 0014	M-14	50	57,63	
0049 0016	M-16	50	60,52	
0049 0018	M-18	25	107,71	
0049 0020	M-20	25	140,43	
0049 0022	M-22	10	208,89	
0049 0024	M-24	10	237,17	
0049 0027	M-27	5	441,41	
0049 0030	M-30	5	581,74	

Price
x 100
units

Ref	M			
0049 10100	M-10 x 1,00	100	125,24	
0049 10125	M-10 x 1,25	50	134,85	
0049 12125	M-12 x 1,25	50	141,57	
0049 12150	M-12 x 1,50	50	153,13	
0049 14150	M-14 x 1,50	50	201,47	
0049 16150	M-16 x 1,50	50	247,83	
0049 18150	M-18 x 1,50	25	391,70	
0049 20150	M-20 x 1,50	25	468,27	

TUERCA HEXAGONAL AUTOBLOCANTE NYLON ZINCADO / ECROUS HEXAGONAUX INDESSERABLES AVEC BAGUE NYLON ZINGUÉ
 HEXAGON LOCKNUT WITH NYLON INSERT ZINC PLATED / DADI ZINCATI ESAGONALI CON INSERTO IN NYLON, AUTOFRENANTI
 PORCA HEXAGONAL AUTO-BLOQUEANTE NYLON ZINCADO

WHITWORTH

Ref. 0041

+ Medida / Dimensions / Size / Dimensioni / Medida



DIN 985

CLASE
 CLASSE
 CLASS **8**

Ref	M				
0041 0014	1/4	20 h	50	118,80	
0041 0516	5/16	18 h	50	132,00	
0041 0038	3/8	16 h	50	181,50	
0041 0716	7/16	14 h	25	224,40	
0041 0012	1/2	12 h	25	297,00	
0041 0012UNC	1/2 UNC	13 h	25	297,00	Price x 100 units
0041 0916	9/16	12 h	10	379,50	
0041 0058	5/8	11 h	10	396,00	
0041 0034	3/4	10 h	5	706,20	
0041 0078	7/8	9 h	5	1108,80	
0041 0001	1	8 h	1	1551,00	

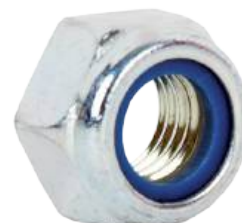

TUERCA HEXAGONAL AUTOBLOCANTE NYLON ZINCADO / ECROUS HEXAGONAUX INDESSERABLES AVEC BAGUE NYLON ZINGUÉ
 HEXAGON LOCKNUT WITH NYLON INSERT ZINC PLATED / DADI ZINCATI ESAGONALI CON INSERTO IN NYLON, AUTOFRENANTI
 PORCA HEXAGONAL AUTO-BLOQUEANTE NYLON ZINCADO

UNF / UNS (SAE)

Ref. 0045

+ Medida / Dimensions / Size / Dimensioni / Medida



DIN 985

CLASE
 CLASSE
 CLASS **8**

Ref	M				
0045 0014	1/4	28 h	50	118,80	
0045 0516	5/16	24 h	50	132,00	
0045 0038	3/8	24 h	50	188,10	
0045 0716	7/16	20 h	25	198,08	
0045 0012	1/2	20 h	25	250,59	Price x 100 units
0045 0916	9/16	18 h	10	379,50	
0045 0058	5/8	18 h	10	396,00	
0045 0034	3/4	16 h	5	749,52	
0045 0078	7/8	14 h	5	1016,40	
0045 0001	1"	12 h	1	1551,00	



TUERCA CIEGA / ECROUS BORGNES / HEXAGON CAP NUT / DADI ESAGONALI CIECHI CON CALOTTA SFERICA / PORCA HEXAGONALTAMPÃO

Ref. 0033

+ Medida / Dimensions / Size / Dimensioni / Medida

DIN 1587



Ref	M			
0033 0004	M-4	500	9,53	Price x 100 units
0033 0005	M-5	500	9,56	
0033 0006	M-6	500	10,37	
0033 0008	M-8	200	21,12	
0033 0010	M-10	100	29,00	
0033 0012	M-12	100	50,77	
0033 0014	M-14	50	109,12	
0033 0016	M-16	50	152,24	
0033 0020	M-20	10	378,18	

TUERCA DE MARIPOSA / ECROUS A OREILLES FORME AMERICAINE / WING NUT AMERICAN TYPE / DADI CON ALETTE / PORCA DE BORBOLETA

Ref. 0034

+ Medida / Dimensions / Size / Dimensioni / Medida

DIN 315



Ref	M			
0034 0003	M-3	500	13,71	Price x 100 units
0034 0004	M-4	500	14,45	
0034 0005	M-5	500	15,37	
0034 0006	M-6	200	16,20	
0034 0008	M-8	200	17,22	
0034 0010	M-10	100	42,14	
0034 0012	M-12	50	78,90	
0034 0014	M-14	50	215,53	

TUERCA HEXAGONAL ALMENADA / ECROUS HEXAGONAUX EN FORME D'AMANDE / SLOTTED HEX NUT
DADI ESAGONALI MERLATI / PORCA SEXTAVADA ENTALHADA

Ref. 0066

+ Medida / Dimensions / Size / Dimensioni / Medida

Rosca métrica ISO paso normal
Filetage métrique ISO à pas gros
ISO metric thread coarse pitch
Filettatura metrica ISO a passo grosso
Rosca métrica ISO passo normal

DIN 935



CLASE
CLASSE
CLASS 8



Ref	M			
0066 0010	M-10	50	84,39	Price x 100 units
0066 0012	M-12	25	91,65	
0066 0014	M-14	25	100,79	
0066 0016	M-16	10	216,71	
0066 0018	M-18	5	350,00	
0066 0020	M-20	5	465,00	
0066 0024	M-24	5	601,54	

CONTRATUERCA / CONTRE-ÉCROU / LOCKNUT / DADO DIBLOCCAGGIO / PORCA DE BLOQUEIO

Ref. 0058

+ Medida / Dimensions / Size / Dimensioni / Medida

+ Z

DIN 936



Ref	M			
0058 0005Z	M-5	500	3,34	Price x 100 units
0058 0006Z	M-6	500	3,62	
0058 0008Z	M-8	200	4,16	
0058 0010Z	M-10	200	9,93	
0058 0012Z	M-12	200	12,39	
0058 0014Z	M-14	200	19,61	
0058 0016Z	M-16	100	23,38	
0058 0018Z	M-18	50	32,77	
0058 0020Z	M-20	50	41,26	
0058 0022Z	M-22	50	65,50	
0058 0024Z	M-24	25	78,30	
0058 0027Z	M-27	25	115,85	
0058 0030Z	M-30	25	140,94	



MANGUITO CILÍNDRICO UNIÓN VARILLAS ROSCADAS / ECROUS CYLINDRIQUE / CYLINDRICAL NUT FOR THREADED RODS
DADI DI GIUNZIONE CILINDRICI, FILETTATI / MANGA CILÍNDRICA PARA UNIÃO DE HASTES ROSCADAS

Ref. 0047

+ Medida / Dimensions / Size / Dimensioni / Medida



Ref				
0047 0532W	5/32 x 20 WHITWORTH	100	18,90	Price x 100 units
0047 0420	M-4 x 20	100	16,19	
0047 0620	M-6 x 20	100	21,15	
0047 0630	M-6 x 30	100	23,12	
0047 0825	M-8 x 25	100	23,97	
0047 0830	M-8 x 30	100	28,10	
0047 1030	M-10 x 30	100	46,01	
0047 1235	M-12 x 35	100	65,46	
0047 1650	M-16 x 50	50	143,47	



MANGUITO HEXAGONAL UNIÓN VARILLAS ROSCADAS / ECROUS HEXAGONAUX / HEXAGON NUT FOR THREADED RODS
DADI DI GIUNZIONE ESAGONALI, FILETTATI / MANGA HEXAGONAL UNIÃO DE HASTES ROSCADAS

Ref. 0048

+ Medida / Dimensions / Size / Dimensioni / Medida



DIN 6334

Ref				
0048 0620	M-6x20	100	21,85	Price x 100 units
0048 0630	M-6x30	100	25,41	
0048 0825	M-8x25	100	40,69	
0048 1030	M-10x30	100	43,90	
0048 1235	M-12x35	100	63,38	
0048 1650	M-16x50	50	205,66	
0048 2060	M-20x60	25	616,15	



TUERCA ABARCÓN / ECROU / NUT FOR U-BOLT / DADO LUNGO / PORCA PARAFUSO

Ref. 0069

+ Medida / Dimensions / Size / Dimensioni / Medida

DIN 6330

Ref				
0069 0010	M-10	100	84,89	Price x 100 units
0069 0012	M-12	100	109,01	
0069 0016	M-16	50	205,28	
0069 0020	M-20	25	561,18	
0069 0024	M-24	25	1166,52	



TUERCA HEXAGONAL "CON BASE" RANURADA / ECROUS HEXAGONAUX AVEC BASE RENUREE / HEX WASHER WITH GROOVED "BASE"
 DADI ESAGONALI "CON BASE" ZIGRINATA / PORCA HEXAGONAL COM BASE RANHURADA

Ref. 0062

+ Medida / Dimensions / Size / Dimensioni / Medida

DIN 6923



CLASE
CLASSE
CLASS **8**



Rosca métrica ISO paso normal
 Filetage métrique ISO à pas gros
 ISO metric thread coarse pitch
 Filettatura metrica ISO a passo grosso
 Rosca métrica ISO passo normal

Ref	M			Price x 100 units
0062 0004	M-4	500	2,45	
0062 0005	M-5	500	2,60	
0062 0006	M-6	200	3,07	
0062 0008	M-8	200	6,66	
0062 0010	M-10	100	10,73	
0062 0012	M-12	100	18,36	

TORNILLO HEXAGONAL "CON BASE" RANURADA / VIS A TETE HEXAGONALE AVEC BASE RENUREE / HEX SCREW WITH GROOVED "BASE"
 VITI ESAGONALI "CON BASE" ZIGRINATA / PARAFUSO HEXAGONAL COM BASE RANHURADA

Ref. 6921

+ Medida / Dimensions / Size / Dimensioni / Medida

DIN 6921



CLASE
CLASSE
CLASS **8.8**



←→	M-5	M-6	M-8	M-10	M-12	Price x 100 units
10	10,27	12,17	.	.	.	
12	10,66	12,75	20,50	.	.	
16	10,86	13,23	22,43	.	.	
20	11,50	14,38	24,20	39,60	.	
25	12,51	16,34	26,48	43,36	67,12	
30	13,95	17,55	28,74	47,07	72,47	
35	.	19,98	32,27	50,72	77,70	
40	.	.	34,98	56,66	82,89	
45	91,73	
50	.	.	40,13	64,86	98,43	
60	.	.	45,86	.	112,53	
≤ 45	200	200	100	100	50	
≥ 50	-	-	-	50	25	

TUERCA AUTOBLOCANTE (SEGURIDAD) CON ARANDELA DE HIERRO ZINCADA



Ref. 0070
+ Medida / Dimensions / Size / Dimensioni / Medida



DIN 6926

CLASE
CLASSE
CLASS **8**

Ref	M			
0070 0005	5	250	4,96	Price x 100 units
0070 0006	6	250	6,44	
0070 0008	8	250	16,20	
0070 0010	10	200	21,15	
0070 0012	12	100	34,66	
0070 0016	16	50	97,46	



TUERCA EMBUTIDA DE HIERRO ZINCADA CON CABEZA ALLEN

Ref. 0077
+ Medida / Dimensions / Size / Dimensioni / Medida



Ref	M			
0077 0613	6 x 13	200	7,78	Price x 100 units
0077 0615	6 x 15	200	8,13	
0077 0620	6 x 20	200	9,66	
0077 0815	8 x 15	100	10,39	
0077 0820	8 x 20	100	11,79	



TUERCA CLAVABLE HIERRO ZINCADA DE 4 GARRAS

Ref. 0078
+ Medida / Dimensions / Size / Dimensioni / Medida



Ref	M			
0078 0004	4	500	6,10	Price x 100 units
0078 0005	5	500	6,14	
0078 0006	6	500	7,22	
0078 0008	8	250	9,33	
0078 0010	10	250	15,36	



ARANDELA PLANA ZINCADO / RONDELLES PLATES DÉCOUPÉES ZINGUÉ / PLAIN STAMPED WASHER ZINC PLATED
 RONDELLE PIATTE ZINCATE / ARRUELA LISA ZINCADA

Ref. 0052

+ Medida / Dimensions / Size / Dimensioni / Medida

DIN 125



Ref	M			
0052 0003	M-3	500	0,39	
0052 0004	M-4	500	0,63	
0052 0005	M-5	500	0,83	
0052 0006	M-6	500	1,02	
0052 0007	M-7	500	1,74	
0052 0008	M-8	500	2,00	
0052 0010	M-10	500	2,84	
0052 0012	M-12	500	5,07	
0052 0014	M-14	200	6,89	
0052 0016	M-16	200	8,80	
0052 0018	M-18	200	11,21	
0052 0020	M-20	200	13,37	
0052 0022	M-22	100	22,74	
0052 0024	M-24	50	31,09	
0052 0027	M-27	50	42,02	
0052 0030	M-30	50	56,34	
0052 0033	M-33	50	90,35	
0052 0036	M-36	25	126,13	
0052 0039	M-39	25	168,33	
0052 0042	M-42	25	252,25	
0052 0045	M-45	25	293,98	
0052 0048	M-48	10	420,10	
0052 0052	M-52	10	504,50	
0052 0056	M-56	10	924,20	
0052 0060	M-60	10	1045,00	

Price
x 100
units

ARANDELA PLANA ALA ANCHA / RONDELLES PLATES / PLAIN WASHER / RONDELLE PIATTE / ARRUELAS LISAS ABA LARGA

Ref. 0053

+ Medida / Dimensions / Size / Dimensioni / Medida



DIN 9021





Ref					
0053 0412	M-4	12 mm	500	1,06	
0053 0515	M-5	15 mm	500	1,18	
0053 0618	M-6	18 mm	500	1,97	
0053 0721	M-7	21 mm	500	4,98	
0053 0824	M-8	24 mm	500	5,60	
0053 1030	M-10	30 mm	300	9,09	
0053 1236	M-12	36 mm	200	16,38	
0053 1442	M-14	42 mm	100	23,60	
0053 1648	M-16	48 mm	100	29,87	
0053 1854	M-18	54 mm	100	53,97	
0053 2060	M-20	60 mm	50	57,20	
0053 2266	M-22	66 mm	20	151,24	
0053 2470	M-24	70 mm	20	185,95	

Price
x 100
units

ARANDELA GROWER ZINCADO / RONDELLES ELASTIQUES "GROWER" ZINGUÉ / SPRING LOCK WASHER ZINC PLATED STEEL
 RONDELLE GROWER ZINCATE / ARRUELAS GROWER ZINCADO



Ref	M			
0057 0003	M-3	500	0,69	Price x 100 units
0057 0004	M-4	500	0,79	
0057 0005	M-5	500	1,05	
0057 0006	M-6	500	1,80	
0057 0008	M-8	500	3,15	
0057 0010	M-10	500	4,90	
0057 0012	M-12	500	6,50	
0057 0014	M-14	200	9,20	

Ref	M			
0057 0016	M-16	200	13,50	Price x 100 units
0057 0018	M-18	100	18,00	
0057 0020	M-20	100	21,10	
0057 0022	M-22	50	25,10	
0057 0024	M-24	50	45,00	
0057 0027	M-27	50	68,00	
0057 0030	M-30	50	130,00	

Ref. 0057
 + Medida / Dimensions / Size / Dimensioni / Medida





ARANDELA CÓNICA ESTRIADA TIPO AET / RONDELLES CONTACT / CONTACTLOCK WASHER
 RANELLE CONICHE ZIGRINATE / ARRUELAS CÔNICAS ESTRIADAS TIPO AET



Ref				
0054 0003	M-3	250	5,21	Price x 100 units
0054 0004	M-4	250	6,14	
0054 0005	M-5	250	12,39	
0054 0006	M-6	250	14,39	
0054 0008	M-8	250	16,10	
0054 0010	M-10	100	29,67	
0054 0012	M-12	100	38,25	
0054 0014	M-14	50	52,42	
0054 0016	M-16	50	53,65	

Ref. 0054
 + Medida / Dimensions / Size / Dimensioni / Medida



ARANDELAS DENTADAS / RONDELLES DENTÉES / SERRATED WASHERS / RONDELLE DENTELLATE / ARRUELAS DENTADAS

Ref				
0075 0003	M-3	200	1,57	Price x 100 units
0075 0004	M-4	200	2,28	
0075 0005	M-5	200	3,03	
0075 0006	M-6	200	7,28	
0075 0008	M-8	200	7,80	
0075 0010	M-10	200	9,06	

Ref				
0075 0012	M-12	100	16,59	Price x 100 units
0075 0014	M-14	100	19,90	
0075 0016	M-16	100	26,43	
0075 0018	M-18	100	34,21	
0075 0020	M-20	50	39,68	
0075 0024	M-24	50	53,95	



Ref. 0075
 + Medida / Dimensions / Size / Dimensioni / Medida



DIN 6797-A



Ref. 0076
 + Medida / Dimensions / Size / Dimensioni / Medida

DIN 6797-J

Ref				
0076 0003	M-3	200	1,70	Price x 100 units
0076 0004	M-4	200	2,40	
0076 0005	M-5	200	3,20	
0076 0006	M-6	200	7,27	
0076 0007	M-8	200	9,30	
0076 0008	M-8	100	10,55	
0076 0010	M-10	100	12,50	

Ref				
0076 0012	M-12	100	16,59	Price x 100 units
0076 0014	M-14	100	19,90	
0076 0016	M-16	100	26,43	
0076 0018	M-18	100	47,85	
0076 0020	M-20	50	53,40	
0076 0022	M-22	50	58,20	



ARANDELA ELÁSTICA EN ABANICO DENTADO EXTERIOR / RONDELLES ÉVENTAIL À DENTURES EXTÉRIEURES
SERRATED LOCK WASHER EXTERNAL TEETH / RANELLE CON DENTATURA ESTERNA / ARRUELAS ELÁSTICAS DENTADAS EXTERNAS

Ref. 0051

+ Medida / Dimensions / Size / Dimensioni / Medida

DIN 6798



Ref	⊖	📦	📊	
0051 0003	M-3	250	0,92	Price x 100 units
0051 0004	M-4	250	1,24	
0051 0005	M-5	250	1,32	
0051 0006	M-6	250	1,65	
0051 0007	M-7	250	3,00	
0051 0008	M-8	250	3,40	
0051 0010	M-10	100	5,79	
0051 0012	M-12	100	8,09	
0051 0014	M-14	50	16,05	
0051 0016	M-16	50	18,10	
0051 0018	M-18	50	30,01	
0051 0020	M-20	50	41,38	

ARANDELAS SEGURIDAD DE DOS SOLAPAS / RONDELLE DE SÉCURITÉ À 2 RABATS / TWO TAB SAFETY WASHER
RONDELLA DI SICUREZZA CON LINGUETTE AD ANGOLO RETTO / ARRUELA SEGURANÇA DE 2 ORELHAS

Ref. 0073

+ Medida / Dimensions / Size / Dimensioni / Medida

DIN 463



Ref	⊖	📦	📊	
0073 0008	M-8	100	35,71	Price x 100 units
0073 0010	M-10	100	38,26	
0073 0016	M-16	100	51,77	
0073 0020	M-20	50	55,20	
0073 0030	M-30	50	150,00	

ARANDELAS DE CUÑA / RONDELLE EN COIN / SQUARE WASHERS / RONDELLA A CUNEO / ANILHAS DE CUNHA

Ref. 0074

+ Medida / Dimensions / Size / Dimensioni / Medida

+ P/Z



DIN 434

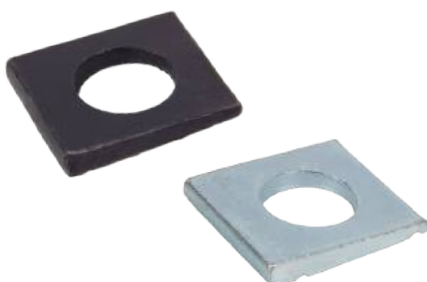

Ref	↔	📦	📊	
0074 0008P	M-8	100	26,92	Price x 100 units
0074 0010P	M-10	100	27,40	
0074 0012P	M-12	100	44,02	
0074 0014P	M-14	100	74,78	
0074 0016P	M-16	50	75,42	
0074 0018P	M-18	50	110,71	
0074 0020P	M-20	50	112,90	
0074 0022P	M-22	25	308,68	
0074 0024P	M-24	25	322,10	
0074 0027P	M-27	25	331,03	

Ref	↔	📦	📊	
0074 0008Z	M-8	100	29,71	Price x 100 units
0074 0010Z	M-10	100	31,15	
0074 0012Z	M-12	100	45,88	
0074 0014Z	M-14	100	81,51	
0074 0016Z	M-16	50	86,50	
0074 0018Z	M-18	50	121,83	
0074 0020Z	M-20	50	124,26	

ARANDELA DE COBRE PARA TAPÓN CÁRTER / RONDELLES DE CUIVRE POUR BOUCHON DE CARTER / COPPER WASHER FOR CRANKCASE
RONDELLE IN RAME PER TAPPO CARTER / ARRUELAS DE COBRE

CONTENIDO / CONTENU / CONTAINS
CONTENUTO / CONTEÚDO

Ref	⊖	⊕	📦	📊	Price x 100 units
0059 1217	12	17	100	22,14	
0059 1420	14	20	100	22,55	
0059 1622	16	22	100	23,34	
0059 1824	18	24	100	25,64	
0059 2026	20	26	100	33,56	
0059 2228	22	28	100	36,12	

Ref	M	📦
0059 1217	12 x 17	50
0059 1420	14 x 20	50
0059 1622	16 x 22	50
0059 1824	18 x 24	50
0059 2026	20 x 26	50
0059 2228	22 x 28	50
0940 0221	Box of 8 sections 190 x 155 x 37	1

Ref. 0059

+ Medida / Dimensions / Size / Dimensioni / Medida



SET 300 pcs (MALETÍN/BOX)

Ref	📊
0401 0061	98,50

ARANDELAS COBRE / RONDELLES CUIVRE / COPPER WASHER / RONDELLE RAME / ARRUELAS DE COBRE

Ref	M	📦	📊	Price x 100 units
0055 0408	4 x 8 x 1,5	100	9,90	
0055 0509	5 x 9 x 1,5	100	10,56	
0055 0610	6 x 10 x 1,5	100	11,22	
0055 0611	6 x 11 x 1,5	100	11,88	
0055 0711	7 x 11 x 1,5	100	12,10	
0055 0712	7 x 12 x 1,5	100	13,86	
0055 0812	8 x 12 x 1,5	100	14,10	
0055 0813	8 x 13 x 1,5	100	14,52	
0055 0814	8 x 14 x 1,5	100	19,80	
0055 0912	9 x 12 x 1,5	100	19,90	
0055 0914	9 x 14 x 1,5	100	20,00	
0055 1014	10 x 14 x 1,5	100	20,20	
0055 1016	10 x 16 x 1,5	100	22,44	
0055 1116	11 x 16 x 1,5	100	22,60	
0055 1117	11 x 17 x 1,5	100	22,70	
0055 1216	12 x 16 x 1,5	100	23,10	
0055 1218	12 x 18 x 1,5	100	24,20	

Ref	M	📦	📊	Price x 100 units
0055 1222	12 x 22 x 1,5	100	41,58	
0055 1318	13 x 18 x 1,5	100	42,60	
0055 1420	14 x 20 x 1,5	100	43,80	
0055 1623	16 x 23 x 1,5	100	46,20	
0055 1722	17 x 22 x 1,5	100	48,50	
0055 1824	18 x 24 x 1,5	100	52,47	
0055 1825	18 x 25 x 1,5	100	53,50	
0055 1926	19 x 26 x 1,5	100	54,60	
0055 2026	20 x 26 x 1,5	100	56,10	
0055 2228	22 x 28 x 1,5	100	61,38	
0055 2430	24 x 30 x 1,5	100	67,65	
0055 2532	25 x 32 x 1,5	100	73,92	
0055 2633	26 x 33 x 1,5	100	84,25	
0055 2836	28 x 36 x 1,5	100	95,70	
0055 3038	30 x 38 x 1,5	100	104,28	
0055 3240	32 x 40 x 1,5	100	116,16	

Ref. 0055

+ Medida / Dimensions / Size / Dimensioni / Medida



SET 400 pcs (MALETÍN/BOX)

Ref	📊
0401 0059	200,35

CONTENIDO / CONTENU / CONTAINS
CONTENUTO / CONTEÚDO

Ref	M	📦
0055 0408	4 x 8 x 1,5	25
0055 0610	6 x 10 x 1,5	25
0055 0813	8 x 13 x 1,5	25
0055 1014	10 x 14 x 1,5	25
0055 1216	12 x 16 x 1,5	25
0055 1218	12 x 18 x 1,5	25
0055 1318	13 x 18 x 1,5	25
0055 1420	14 x 20 x 1,5	25
0055 1623	16 x 23 x 1,5	25
0055 1722	17 x 22 x 1,5	25
0055 1824	18 x 24 x 1,5	25
0055 1825	18 x 25 x 1,5	25
0055 2026	20 x 26 x 1,5	25
0055 2228	22 x 28 x 1,5	15
0055 2430	24 x 30 x 1,5	15
0055 2633	26 x 33 x 1,5	15
0055 2836	28 x 36 x 1,5	15
0055 3038	30 x 38 x 1,5	15
0940 0223	Box of 22 sections 364 x 268 x 66	1





ARANDELA DE ALUMINIO / RONDELLES ALUMINIUM / ALUMINIUM WASHER / RONDELLE ALLUMINIO / ARRUELA DE ALUMÍNIO

Ref. 0056

+ Medida / Dimensions / Size / Dimensioni / Medida



Ref	M			
0056 0408	4 x 8 x 1,5	100	3,30	
0056 0509	5 x 9 x 1,5	100	3,35	
0056 0610	6 x 10 x 1,5	100	3,40	
0056 0611	6 x 11 x 1,5	100	3,45	
0056 0711	7 x 11 x 1,5	100	3,50	
0056 0712	7 x 12 x 1,5	100	3,55	
0056 0812	8 x 12 x 1,5	100	3,60	
0056 0813	8 x 13 x 1,5	100	3,63	
0056 0814	8 x 14 x 1,5	100	3,96	
0056 0912	9 x 12 x 1,5	100	4,10	
0056 0914	9 x 14 x 1,5	100	4,20	
0056 1014	10 x 14 x 1,5	100	4,30	
0056 1016	10 x 16 x 1,5	100	4,40	
0056 1116	11 x 16 x 1,5	100	4,45	
0056 1117	11 x 17 x 1,5	100	4,50	
0056 1216	12 x 16 x 1,5	100	4,55	
0056 1218	12 x 18 x 1,5	100	4,60	
0056 1222	12 x 22 x 1,5	100	4,65	
0056 1318	13 x 18 x 1,5	100	4,70	
0056 1418	14 x 18 x 1,5	100	4,95	
0056 1420	14 x 20 x 1,5	100	5,94	
0056 1623	16 x 23 x 1,5	100	7,26	
0056 1722	17 x 22 x 1,5	100	7,50	
0056 1824	18 x 24 x 1,5	100	7,92	
0056 1825	18 x 25 x 1,5	100	8,25	
0056 1926	19 x 26 x 1,5	100	8,65	
0056 2026	20 x 26 x 1,5	100	8,91	
0056 2226	22 x 26 x 1,5	100	9,55	
0056 2228	22 x 28 x 1,5	100	10,56	
0056 2430	24 x 30 x 1,5	100	11,88	
0056 2532	25 x 32 x 1,5	100	13,20	
0056 2633	26 x 33 x 1,5	100	14,60	
0056 2836	28 x 36 x 1,5	100	16,50	
0056 3038	30 x 38 x 1,5	100	18,48	
0056 3240	32 x 40 x 1,5	100	21,12	

Price
x 100
unitsCONTENIDO / CONTENU / CONTAINS
CONTENUTO / CONTEÚDO

Ref	M	
0056 0408	4 x 8 x 1,5	50
0056 0610	6 x 10 x 1,5	50
0056 0712	7 x 12 x 1,5	50
0056 0814	8 x 14 x 1,5	50
0056 1014	10 x 14 x 1,5	50
0056 1218	12 x 18 x 1,5	50
0056 1318	13 x 18 x 1,5	50
0056 1418	14 x 18 x 1,5	50
0056 1623	16 x 23 x 1,5	50
0056 1722	17 x 22 x 1,5	50
0056 1824	18 x 24 x 1,5	50
0056 1926	19 x 26 x 1,5	50
0056 2026	20 x 26 x 1,5	50
0056 2228	22 x 28 x 1,5	50
0056 2430	24 x 30 x 1,5	15
0056 2633	26 x 33 x 1,5	15
0056 2836	28 x 36 x 1,5	15
0056 3038	30 x 38 x 1,5	15
0940 0223	Box of 22 sections 364 x 268 x 66	1

SET 400 pcs (MALETÍN/BOX)

Ref	
0401 0058	69,80



ARANDELA METAL GOMA / RONDELLE MÉTAL CAOUTCHOUC / METAL RUBBER WASHER / RONDELLA METALLO GOMMA / ANILHA METAL BORRACHA

ES Arandela de metal goma fabricada en acero zincado de alta calidad, cuenta con un anillo interior fabricado en caucho. Actúa como junta de estanqueidad para sistemas hidráulicos y neumáticos. Esta arandela está formada por una parte exterior de acero zincado (AISI 1008-1010) y, en su parte interior, una junta de sección trapezoidal de NBR. Para asegurar una perfecta estanqueidad, asegúrese de que la temperatura se encuentra entre -30°C y 110°C. Adecuada para su aplicación en cabezas de tornillo, racores de unión, tapones, racores orientables y tuercas ciegas.

FR Rondelle en métal caoutchouc fabriquée en acier zingué de haute qualité, elle possède un anneau intérieur fabriqué en caoutchouc. Elle agit comme joint d'étanchéité pour les systèmes hydrauliques et pneumatiques. Cette rondelle est formée par une partie extérieure en acier zingué (AISI 1008-1010) et, dans sa partie intérieure, un joint de section trapézoïdale en NBR. Pour assurer une étanchéité parfaite, vérifiez que la température se trouve entre -30°C et 110°C. Convient pour l'application sur les têtes de vis, raccords, bouchons, raccords orientables et écrous aveugles.

EN This metal rubber washer is made of high quality zinc-plated steel. It has an inner ring made of rubber. It acts as a sealing gasket for hydraulic and pneumatic systems. This washer consists of a zinc-plated steel outer side (AISI 1008-1010) and a trapezoidal section gasket, in its inner side, made of NBR. To ensure a perfect sealing, make sure that the temperature is between -30°C and 110°C. It is suitable to use on screw heads, pipe fittings, plugs, swivel fittings and acorn nuts.

IT Rondella di metallo e gomma realizzata in acciaio zincato di alta qualità; è dotata di un anellino interno in caucciù. Funziona come guarnizione di tenuta in sistemi idraulici e pneumatici. Questa rondella è formata da una parte esterna in acciaio zincato (AISI 1008-1010) e da una guarnizione con sezione trapezoidale di NBR nella parte interna. Per una tenuta stagna ottimale, assicurarsi che la temperatura sia tra i -30°C e i 110°C. Ideale da usare sulle teste delle viti, raccordi di unione, raccordi orientabili e dadi ciechi.

PT Anilha de metal e borracha fabricada de aço zincado de alta qualidade, possui um anel interior de borracha. Atua como uma junta de vedação para sistemas hidráulicos e pneumáticos. Esta anilha é composta por uma parte exterior em aço galvanizado (AISI 1008-1010) e, na parte interior, uma junta de seção trapezoidal em NBR. Para garantir uma vedação perfeita, certifique-se de que a temperatura esteja entre -30°C e 110°C. Adequada para aplicação em cabeças de parafusos, racores de união, bujões, racores ajustáveis e porcas.

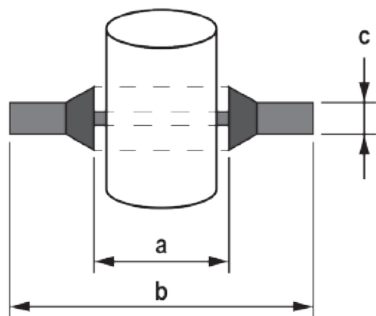

Rosca métrica

Ref	a	b	c	max			Price x 100 units
0079 0006	M-6	11 mm	1 mm	1510 bar	100	25,92	
0079 0008	M-8	13 mm	1 mm	1330 bar	100	29,28	
0079 0010	M-10	16 mm	1,5 mm	1350 bar	100	31,68	
0079 0012	M-12	18 mm	1,5 mm	1250 bar	100	32,64	
0079 0014	M-14	22 mm	1,5 mm	1510 bar	100	33,60	
0079 0016	M-16	24 mm	1,5 mm	1400 bar	100	33,60	
0079 0018	M-18	26 mm	1,5 mm	1275 bar	100	37,44	
0079 0020	M-20	28 mm	1,5 mm	1150 bar	100	42,24	
0079 0022	M-22	30 mm	2 mm	1100 bar	100	45,12	
0079 0024	M-24	32 mm	2 mm	1050 bar	100	55,20	
0079 0026	M-26	35 mm	2 mm	1050 bar	100	61,92	

Rosca pulgada

Ref	a	b	c	max			Price x 100 units
0079 0108	1/8"	15,88 mm	2 mm	1500 bar	100	28,80	
0079 0104	1/4"	20,57 mm	2 mm	1550 bar	100	28,80	
0079 0308	3/8"	23,80 mm	2 mm	1260 bar	100	31,20	
0079 0102	1/2"	28,58 mm	2,5 mm	1150 bar	100	36,96	
0079 0304	3/4"	34,93 mm	2,5 mm	1060 bar	100	41,76	
0079 0100	1"	42,80 mm	2,5 mm	810 bar	100	74,40	
0079 0114	1" 1/4	52,38 mm	3,25 mm	690 bar	25	111,84	
0079 0112	1" 1/2	58,60 mm	3,25 mm	690 bar	25	133,92	
0079 0200	2"	73,03 mm	3,25 mm	700 bar	25	186,72	

ROTOVATOR / ROTOVATEUR / ROTOVATOR / ROTOVATOR / ROTOVATOR

ARANDELA ROTOVATOR GROWER / RONDELLE ROTOVATEUR GROWER / ROTOVATOR GROWER SPRING WASHER / RONDELLA ROTOVATOR GROWER / ANILHA ROTOVATOR GROWER

Ref. 0057
+ Medida / Dimensions / Size / Dimensioni / Medida + P



Ref	Ø			Price x 100 units
0057 0011P	11 mm	100	4,68	Price x 100 units
0057 0013P	13 mm	100	5,38	

TUERCA CUCHILLA DE ROTOVATOR / ÉCROU DE LAME DE ROTOVATEUR / NUT ROTOVATOR BLADE
DADO LAMA DI ROTOVATOR / PORCA LAMINA DE ROTOVATOR

Ref. 0089

+ Medida / Dimensions / Size / Dimensioni / Medida



BLACK

Rosca UNF/SAE / Filetage UNF/SAE
Thread UNF/SAE / Filettatura UNF/SAE
Rosca UNF/SAE

Ref	M			Price
0089 0012	1/2"	100	18,10	x 100 units
0089 0716	7/16"	100	23,00	

TORNILLO CUCHILLA DE ROTAVATOR / VIS DE LAME DE ROTOVATEUR / SCREW ROTOVATOR BLADE
VITE LAMA DI ROTOVATOR / PARAFUSO LAMINA DE ROTOVATOR

Ref. 0088

+ Medida / Dimensions / Size / Dimensioni / Medida



CLASE
CLASSE
CLASS **8.8**

BLACK

Rosca UNF/SAE / Filetage UNF/SAE
Thread UNF/SAE / Filettatura UNF/SAE
Rosca UNF/SAE

Ref	←	M			Price
			7/16"	1/2"	
0088 71635	35	7/16"	48,10	-	x 100 units
0088 1238	38	1/2"	-	56,30	

AUTOTALADRANTE / VIS AUTOPERCEUSES / SELF-DRILLING SCREW VITI AUTOPERFORANTI / AUTOPERFORANTE

TORNILLO AUTOTALADRANTE CABEZA EXTRAPLANA PHILLIPS / VIS AUTOPERCEUSES TÊTE CYLINDRIQUE EXTRAPLATE EMPREINTE PHILLIPS
SELF-DRILLING SCREW PAN HEAD SLIMLINE PHILLIPS RECESS / VITI AUTOPERFORANTI ULTRASOTTILI PHILLIPS
PARAFUSO AUTOPERFORANTE CABEÇA EXTRA-PLANA PHILLIPS

Ref. 0208

+ Medida / Dimensions / Size / Dimensioni / Medida



ZINC
PLATED

Ref				Price
0208 4214	4,2 x 14 mm	500	2,90	x 100 units
0208 4223	4,2 x 23 mm	500	4,20	

Ref. 0208

+ Medida / Dimensions / Size / Dimensioni / Medida
+ N



BLACK

Ref				Price
0208 4214N	4,2 x 14 mm	500	4,32	x 100 units
0208 4223N	4,2 x 23 mm	250	6,25	

Ref. 0208

+ Medida / Dimensions / Size / Dimensioni / Medida
+ B



WHITE

Ref				Price
0208 4214B	4,2 x 14 mm	500	6,86	x 100 units
0208 4223B	4,2 x 23 mm	500	9,57	

Ref. 0208

+ Medida / Dimensions / Size / Dimensioni / Medida
+ I



INOX
A-2

Ref				Price
0208 4214I	4,2 x 14 mm	500	35,72	x 100 units

TORNILLO DE CUBIERTA CON ARANDELA ACERO EPDM ZINCADO / VIS AUTOPERCEUSES AVEC RONDELLE EPDM ACIER ZINGUÉ
SELF DRILLING SCREW WITH NEOPRENE WASHER ZINC PLATED / VITI ZINCATE AUTOPERFORANTI CON RONDELLE IN ACCIAIO EPDM
PARAFUSO AUTO-PERFORANTE COM ARRUELA EM AÇO EPDM ZINCADO

Ref. 0205

+ Medida / Dimensions / Size / Dimensioni / Medida

Ref					
0205 4816	4,8x16	14 mm	1.000	6,38	
0205 4819	4,8x19	14 mm	1.000	6,73	
0205 4819A	4,8x19	16 mm	1.000	7,01	
0205 5522	5,5x22	16 mm	200	8,98	
0205 5538	5,5x38	16 mm	200	10,73	
0205 5550	5,5x50	16 mm	200	13,57	Price x 100 units
0205 6325	6,3x25	16 mm	200	14,20	
0205 6338	6,3x38	16 mm	200	15,04	
0205 6350	6,3x50	16 mm	100	18,03	
0205 6360	6,3x60	16 mm	100	20,69	
0205 6380	6,3x80	16 mm	100	28,40	
0205 6390	6,3x90	16 mm	100	28,78	
0205 63100	6,3x100	16 mm	100	32,64	



DIN 7504K

+ EPDM WASHERS



TORNILLO AUTOTALADRANTE CON ARANDELA ACERO EPDM PANEL SANDWICH / VIS AUTOPERCEUSES AVEC RONDELLE EPDM ACIER
SELF-DRILLING SCREW WITH NEOPRENE WASHER / VITI AUTOPERFORANTI CON RONDELLE IN ACCIAIO EPDM PER PANNELLI SANDWICH
PARAFUSO AUTO-PERFORANTE COM ARRUELA EM AÇO EPDM PAINEL SANDWICH

Ref. 0205

+ Medida / Dimensions / Size / Dimensioni / Medida

Ref					
0205 6382	5,5/6,3x82	16 mm	50	35,05	Price x 100 units
0205 6398	5,5/6,3x98	16 mm	50	45,71	
0205 63115	5,5/6,3x115	16 mm	50	54,33	



TORNILLO DE CUBIERTA CON ARANDELA ACERO EPDM PARA VIGUETA ZINCADO / VIS AUTOPERCEUSES AVEC RONDELLE EPDM ACIER ZINGUÉ
SELF-DRILLING SCREW WITH NEOPRENE WASHER ZINC PLATED / À VITI ZINCATE AUTOPERFORANTI CON RONDELLE IN ACCIAIO EPDM
PARAFUSO AUTO-PERFORANTE COM ARRUELA EM AÇO EPDM PARA VIGA ZINCADO

Ref. 0206

+ Medida / Dimensions / Size / Dimensioni / Medida

Ref					
0206 5528	5,5x28	16 mm	100	14,08	Price x 100 units
0206 5532	5,5x32	16 mm	100	14,64	
0206 5538	5,5x38	16 mm	100	14,69	



TORNILLO AUTOTALADRANTE CABEZA HEXAGONAL CON COLLARÍN ZINCADO / VIS AUTOPERCEUSES TÊTE HEXAGONALE A EMBASE ZINGUÉ
SELF-DRILLING SCREW HEXAGON HEAD WITH FLANGE ZINC PLATED / VITI ZINCATE AUTOPERFORANTI CON TESTA ESAGONALE E FLANGIA PIATTA
PARAFUSO AUTOPERFORANTE ZINCADO CABEÇA HEXAGONAL COM COLARINHO

Ref. 0204

+ Medida / Dimensions / Size / Dimensioni / Medida

DIN 7504K



↔	M-3.5	M-4.2	M-4.8	M-5.5	M-6.3	
13	3,09	2,93	4,19	.	.	Price x 100 units
16	3,10	3,26	4,35	.	.	
19	.	3,39	4,51	6,28	8,59	
22	.	.	.	6,43	.	
25	4,08	3,96	4,99	6,57	10,61	
32	.	4,64	5,89	7,69	11,10	
38	.	6,72	7,71	8,68	13,75	
45	.	.	7,99	.	.	
50	.	.	8,27	10,78	14,34	
63	.	.	.	12,58	17,08	
≤ 19	1000	1000	1000	500	250	
≥ 22	1000	500	500	500	250	

ARANDELA ESTANQUEIDAD EPDM / RONDELLES D'ETANCHEITE AVEC JOINT NÈOPRÈNE / NEOPRENE WASHER
RONDELLE DI TENUTA EPDM / ARRUELA DE VEDAÇÃO EPDM

Ref. 0207

+ Medida / Dimensions / Size / Dimensioni / Medida



Ref	∅	⊙			
0207 0014	14 mm	4,8 mm	100	3,23	Price x 100 units
0207 0016	16 mm	5,5 mm	100	3,49	
0207 0018	18 mm	5,5 mm	100	4,68	
0207 0025	25 mm	6,3 mm	100	7,92	
0207 0025L	25 mm	8,0 mm	100	8,35	

TORNILLO AUTOTALADRANTE CABEZA CILÍNDRICA PHILLIPS ZINCADO / VIS AUTOPERCEUSES TÊTE CYLINDRIQUE EMPREINTE PHILLIPS ZINGUÉ
SELF-DRILLING SCREW PAN HEAD PHILLIPS RECESS ZINC PLATED / VITI ZINCATE AUTOPERFORANTI CON TESTA CILINDRICA PHILLIPS
PARAFUSO AUTOPERFORANTE ZINCADO CABEÇA CILÍNDRICA PHILLIPS

Ref. 0202

+ Medida / Dimensions / Size / Dimensioni / Medida

←→	M-3.5	M-3.9	M-4.2	M-4.8	M-5.5	M-6.3	
9,5	1,82	
11	2,08	
13	2,15	2,22	2,40	3,59	.	.	
16	2,23	2,29	2,92	3,77	.	.	
19	2,30	2,70	3,10	4,05	5,61	.	
22	2,51	2,85	3,27	4,44	.	.	
25	2,80	3,00	3,56	4,81	7,39	9,90	
32	3,07	3,09	4,60	5,38	7,43	.	
38	.	.	4,80	6,25	7,47	10,07	Price
45	.	.	.	7,23	7,99	11,84	x 100
50	.	.	5,62	7,96	8,84	.	units
63	.	.	.	9,26	12,67	.	
75	.	.	.	10,19	15,49	.	
90	.	.	.	14,12	.	.	
100	.	.	.	15,09	.	.	
≤ 13	500	500	500	250	.	.	
16 - 19	500	500	500	250	250	250	
≥ 22	500	500	250	250	250	250	



DIN 7504N



TORNILLO AUTOTALADRANTE CABEZA AVELLANADA PHILLIPS ZINCADO / VIS AUTOPERCEUSES TÊTE FRAISÉE EMPREINTE PHILLIPS ZINGUÉ
SELF-DRILLING SCREW COUNTERSUNK HEAD PHILLIPS RECESS ZINC PLATED / VITI ZINCATE AUTOPERFORANTI CON TESTA SVASATA PHILLIPS
PARAFUSO AUTOPERFORANTE ZINCADO CABEÇA ESCAREADA PHILLIPS

Ref. 0203

+ Medida / Dimensions / Size / Dimensioni / Medida

←→	M-3.5	M-3.9	M-4.2	M-4.8	M-5.5	M-6.3	
13	1,62	1,90	2,11	3,21	.	.	
16	1,96	2,27	2,48	3,58	.	.	
19	2,08	2,50	2,73	3,98	5,73	7,63	
22	.	2,79	3,09	4,28	.	.	
25	2,40	3,04	3,22	5,02	6,00	7,88	
32	.	3,43	4,14	5,30	7,00	9,60	Price
38	.	3,98	4,71	5,47	8,62	10,62	x 100
50	.	.	.	7,50	10,86	12,50	units
≤ 19	500	500	500	500	250	250	
≥ 22	500	500	250	250	250	250	



DIN 7504P



TORNILLOS CABEZA CILÍNDRICA RANURADA ZINCADO / VIS A METAUX TÊTE CYLINDRIQUE FENDUE ZINGUÉ
SLOTTED CHEESE HEAD MACHINE SCREW ZINC PLATED / VITI ZINCATE TESTA CILINDRICA CACCIAVITE A TAGLIO
PARAFUSO CABAÇA CILÍNDRICA ZINCADO

Ref. 0060

+ Medida / Dimensions / Size / Dimensioni / Medida

DIN 84



↔	M-2,5	M-3	M-4	M-5	M-6	M-8	M-10	
6	4,09	2,30	3,16	
8	4,20	2,35	3,50	5,54	7,74	.	.	
10	4,28	2,59	3,77	5,70	8,79	.	.	
12	4,35	2,79	3,93	5,85	9,06	.	.	
16	4,70	3,00	4,16	6,67	9,68	18,65	.	
20	7,28	3,10	4,77	7,79	11,44	20,94	40,26	
25	.	3,49	5,50	8,78	13,53	23,80	52,21	
30	.	4,14	6,49	10,43	14,74	28,39	56,30	
35	.	5,34	7,25	11,35	16,50	29,59	.	
40	.	5,54	8,07	12,80	18,15	32,44	63,73	
45	.	.	8,67	14,59	19,58	.	.	Price
50	.	12,08	9,86	16,72	20,22	38,13	.	x 100
60	.	15,97	16,61	20,91	23,71	44,47	.	units
70	.	.	22,44	24,98	29,68	63,10	.	
80	.	34,98	30,73	30,25	40,55	67,47	.	
90	51,43	.	.	
100	54,81	.	.	
≤ 20	200	200	200	200	200	200	100	
25 - 50	.	200	200	200	200	200	100	
≥ 60	.	200	200	200	100	100	.	

TORNILLOS CABEZA ALOMADA CILÍNDRICA RANURADA ZINCADO / VIS TÊTE CYLINDRIQUE RAINUREE ZINGUEE
CYLINDRICAL SLOTTED CHEESE HEAD SCREW ZINC PLATED / VITI ZINCATE CON TESTA PIATTA A TAGLIO
PARAFUSO CABAÇA CILÍNDRICA ZINCADO

Ref. 0063

+ Medida / Dimensions / Size / Dimensioni / Medida

DIN 85



↔	M-3	M-4	M-5	M-6	
6	2,11	2,67	4,69	.	
8	2,15	2,74	4,85	6,51	
10	2,17	3,19	5,14	6,69	
12	2,31	3,33	5,20	7,13	
15	2,46	3,74	5,61	7,72	
20	3,09	4,18	6,27	8,29	
25	3,14	4,36	6,44	8,33	
30	3,41	5,06	7,26	9,24	Price
35	.	5,94	7,77	10,24	x 100
40	6,23	7,04	9,41	12,24	units
50	.	8,80	11,32	14,19	
60	.	.	.	20,99	
≤ 20	200	200	200	200	
25 - 50	200	200	200	200	
≥ 60	200	200	200	100	

TORNILLO CABEZA CILÍNDRICA ABOMBADA POZIDRIVE ZINCADO / VIS À MÉTAUX TÊTE CYLINDRIQUE EMPREINTE POZIDRIVE ZINGUÉ
POZIDRIVE CROSS RECESSED PAN HEAD MACHINE SCREW ZINC PLATED / VITI ZINCATE CON TESTA CILINDRICA BOMBATA POZIDRIVE
PARAFUSO CABEÇA CILÍNDRICA ABAULADA. POZIDRIVE ZINCADO

Ref. 0064

+ Medida / Dimensions / Size / Dimensioni / Medida



DIN 7985

↔	M-3	M-4	M-5	M-6	
6	6,09	6,42	.	.	
8	6,49	6,49	7,37	.	
10	6,58	6,67	7,68	12,53	
12	6,67	6,82	8,01	12,84	
16	6,82	7,22	8,49	13,72	
20	7,05	7,54	9,04	14,34	
25	7,29	8,01	9,75	15,30	
30	7,46	9,12	11,09	16,25	
35	.	9,59	11,80	16,60	Price x 100 units
40	.	11,24	13,19	18,04	
45	.	.	14,29	.	
50	.	.	15,39	21,87	
60	.	.	.	31,54	
80	.	.	.	36,39	
≤ 16	200	200	200	200	
20 - 40	200	200	200	200	
≥ 45	.	.	200	200	



TORNILLOS CABEZA AVELLANADA RANURADA ZINCADO / VIS À MÉTAUX TÊTE FRAISÉE FENDUE ZINGUÉ
SLOTTED COUNTERSUNK HEAD MACHINE SCREW ZINC PLATED / VITI ZINCATE TESTA SVASATA CACCIAVITE A TAGLIO
PARAFUSO CABEÇA ESCAREADA ZINCADO

Ref. 0061

+ Medida / Dimensions / Size / Dimensioni / Medida



DIN 963

↔	M-3	M-4	M-5	M-6	M-8	M-10	M-12	
6	2,04	
8	2,11	2,98	4,76	
10	2,17	3,06	4,93	7,11	.	.	.	
12	2,29	3,16	4,97	7,26	.	.	.	
16	2,51	3,96	5,45	8,38	19,35	.	.	
20	2,88	4,94	6,53	9,10	19,98	38,50	.	
25	3,93	5,25	7,66	11,11	22,18	39,23	57,94	
30	4,18	5,90	8,71	13,48	24,28	41,64	71,43	
35	5,49	7,35	10,03	14,30	27,54	48,03	74,91	
40	5,82	7,90	11,09	15,85	32,00	54,08	81,27	Price x 100 units
45	.	9,32	13,19	17,93	34,71	60,84	.	
50	9,28	11,92	14,66	19,69	37,09	63,67	99,97	
60	.	13,32	18,28	23,50	43,57	65,40	112,13	
70	.	.	22,28	27,29	50,56	80,15	.	
80	.	.	26,96	40,48	58,50	90,35	.	
90	.	.	37,80	47,86	.	.	.	
100	.	.	.	52,83	.	.	.	
≤ 20	200	200	200	200	200	200	.	
25 - 50	200	200	200	200	200	100	50	
≥ 60	.	.	200	100	100	50	50	



TORNILLO CABEZA AVELLANADA POZIDRIVE ZINCADO / VIS À MÉTAUX TÊTE FRAISÉE EMPREINTE POZIDRIVE ZINGUÉ
POZIDRIVE CROSS RECESSED COUNTERSUNK HEAD SCREW ZINC PLATED / VITI ZINCATE A TESTA SVASATA CACCIAVITE A CROCE
PARAFUSO CABEÇA ESCAREADA POZIDRIVE ZINCADO

Ref. 0065

+ Medida / Dimensions / Size / Dimensioni / Medida

DIN 965



↔	M-3	M-4	M-5	M-6	M-8	
6	6,81	Price x 100 units
8	6,90	6,74	.	.	.	
10	7,00	6,82	7,68	12,53	.	
12	7,12	7,10	8,01	13,30	.	
16	7,26	7,40	10,71	14,34	.	
20	7,45	7,88	11,05	14,95	28,22	
25	8,76	8,72	11,45	15,30	29,62	
30	.	8,89	11,90	16,25	38,93	
40	.	11,28	12,29	18,94	.	
50	.	.	.	22,51	41,50	
60	.	.	.	25,94	.	
≤ 20	200	200	200	100	.	
≥ 25	200	200	200	100	100	

TORNILLO ROSCA MÉTRICA CABEZA GOTA DE SEBO ZINCADO / VIS FILETEE METAL DEMI RONDE ZINGUÉE / ROUND METAL HEAD SCREW ZINC PLATED
VITI ZINCATE CON FILETTATURA METRICA E TESTA A CROCE / PARAFUSO ROSCA METAL CABEÇA REDONDA ZINCADO

Ref. 0068

+ Medida / Dimensions / Size / Dimensioni / Medida

DIN 966



↔	M-3	M-4	M-5	M-6	
5	1,86	.	.	.	Price x 100 units
8	1,89	.	.	.	
10	1,91	2,60	3,99	6,07	
12	1,96	.	4,20	6,26	
15	.	2,96	4,63	6,66	
20	2,33	3,34	5,20	7,66	
25	.	3,71	5,89	8,54	
30	.	4,44	6,63	9,79	
35	.	.	7,50	.	
40	.	.	8,37	11,74	
50	.	.	.	15,50	
≤ 20	200	200	200	100	
≥ 25	200	200	200	100	

TIRAFONDOS ZINCADO / VIS À BOIS TÊTE HEXAGONALE ZINGUÉ / HEXAGON HEAD WOOD SCREW ZINC PLATED
TIRAFONDI ZINCATI PER LEGNO TESTA ESAGONALE / PARAFUSOS ZINCADOS

↔	M-5	M-6	M-7	M-8	M-10	M-12	M-16
25	4,25	5,31	.	11,39	.	.	.
30	4,93	6,07	9,11	12,67	23,22	.	.
35	5,46	6,75	12,29	12,97	25,34	.	.
40	6,22	7,51	12,45	14,34	25,81	.	.
45	6,90	8,27	12,60	15,63	27,62	.	.
50	7,51	8,80	12,75	16,62	29,45	39,60	.
60	8,72	10,24	14,87	17,83	33,46	43,10	.
70	.	11,99	17,23	21,55	37,26	50,42	.
80	.	13,28	20,19	24,89	41,97	56,23	.
90	.	15,79	23,07	25,34	46,90	61,84	118,54
100	.	17,20	25,19	31,49	53,20	70,29	128,57
110	.	19,12	26,79	35,67	59,81	76,03	.
120	.	20,71	30,28	36,58	62,46	78,01	161,57
130	.	.	.	40,99	70,88	89,15	.
140	.	.	42,57	43,71	74,91	95,50	234,80
150	.	.	46,52	46,52	75,59	102,76	250,20
160	.	.	.	49,34	84,39	118,27	269,45
180	.	.	.	55,86	95,48	141,64	311,00
200	105,50	147,77	321,30
220	163,79	172,92	.
240	190,43	185,92	365,00
260	214,17	385,00
300	265,12	.
☞							
≤ 70	200	200	200	100	100	50	25
75 - 150	.	100	100	50	50	25	25
≥ 160	.	.	.	25	25	10	10

Price x 100 units

Ref. 0126

+ Medida / Dimensions / Size / Dimensioni / Medida



DIN 571



TORNILLO ROSCACHAPA CABEZA HEXAGONAL CON ARANDELA ESTAMPADA ZINCADO
VIS AUTOFOREUSES TÊTE HEXAGONALE AVEC RONDELLE ESTAMPÉE ZINGUÉ / HEXAGON WASHER HEAD TAPPING SCREW ZINC PLATED
VITI ZINCATE AUTOFILETTANTI CON TESTA ESAGONALE / PARAFUSO AUTORROSCANTE CABEÇA HEXAGONAL COM ARRUELA ESTAMPADA ZINCADO

Ref. 0209

+ Medida / Dimensions / Size / Dimensioni / Medida



DIN 6928

Ref	⊕	☞	📦	📏
0209 6319	6,3 x 19 mm	250	9,25	
0209 6325	6,3 x 25 mm	250	10,53	
0209 6332	6,3 x 32 mm	250	12,11	
0209 6340	6,3 x 40 mm	250	13,73	
0209 6350	6,3 x 50 mm	250	14,36	
0209 6360	6,3 x 60 mm	100	15,92	
0209 6380	6,3 x 80 mm	100	24,38	
0209 63100	6,3 x 100 mm	100	27,80	
0209 63110	6,3 x 110 mm	100	32,29	
0209 63120	6,3 x 120 mm	100	35,50	
0209 63130	6,3 x 130 mm	100	43,65	
0209 63140	6,3 x 140 mm	100	55,57	
0209 63150	6,3 x 150 mm	100	78,06	

Price x 100 units



TORNILLO ROSCACHAPA CABEZA CILÍNDRICA ABOMBADA PHILLIPS ZINCADO / VIS À TÔLE TÊTE CYLINDRIQUE LARGE EMPREINTE PHILLIPS ZINGUÉ
PHILLIPS CROSS RECESSED PAN HEAD SELF TAPPING SCREW ZINC PLATED / VITI ZINCATE AUTOFIETTANTI CON TESTA CILINDRICA BOMBATA PHILLIPS
PARAFUSO AUTORROSCANTE CABEÇA CILÍNDRICA ABAULADA PHILLIPS ZINCADO

Ref. 0111

+ Medida / Dimensions / Size / Dimensioni / Medida

DIN 7981



↔	M-2,9	M-3,5	M-3,9	M-4,2	M-4,8	M-5,5	M-6,3
6,5	1,43	1,50	2,05
9,5	1,58	1,70	2,10
13	1,60	1,96	2,44	2,64	4,42	4,69	6,86
16	2,11	2,10	2,64	2,88	4,60	5,45	9,90
19	2,44	2,42	2,83	3,50	4,79	5,74	10,30
22	2,90	3,15	3,54	4,40	5,35	6,01	10,70
25	3,04	3,37	3,82	4,50	5,52	6,56	11,09
32	.	3,70	4,42	4,82	7,33	9,44	14,19
38	.	4,16	5,08	5,94	8,40	9,75	15,91
45	.	.	5,49	6,20	9,70	11,25	21,45
50	.	.	5,85	6,50	10,50	12,21	22,50
60	.	.	.	8,27	13,20	15,51	25,01
70	.	.	.	10,36	15,52	22,44	27,65
80	15,80	23,10	28,25
90	16,20	.	.
100	18,62	.	.
📦							
≤ 50	500	500	500	500	500	500	200
≥ 60	.	.	.	500	200	200	200

Price
x 100
units

TORNILLO ROSCACHAPA CABEZA AVELLANADA PHILLIPS / VIS À TÔLE TÊTE FRAISÉE EMPREINTE PHILLIPS ZINGUÉ
PHILLIPS CROSS RECESSED COUNTERSUNK HEAD SELF TAPPING SCREW ZINC PLATED
VITI ZINCATE AUTOFIETTANTI PHILLIPS CACCIAVITE A STELLA TESTA SVASATA / PARAFUSO AUTORROSCANTE CABEÇA ESCAREADA PHILLIPS

Ref. 0113

+ Medida / Dimensions / Size / Dimensioni / Medida

DIN 7982

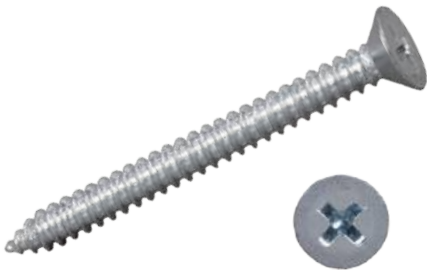

↔	M-2,9	M-3,5	M-3,9	M-4,2	M-4,8	M-5,5	M-6,3
6,5	1,25
9,5	1,30	1,62	1,70
13	1,85	1,65	1,78	2,57	3,96	.	.
16	1,90	2,05	2,90	2,71	4,00	.	.
19	1,95	2,20	3,00	3,37	4,40	5,81	8,25
25	.	3,19	3,28	3,95	5,28	9,57	10,67
32	.	3,66	4,03	4,48	6,05	11,35	11,30
38	.	4,09	6,27	5,68	6,84	12,25	13,20
45	.	.	6,65	5,72	9,24	.	.
50	.	.	.	6,30	10,10	16,50	16,10
📦							
ALL	500	500	500	500	200	200	200

Price
x 100
units

TORNILLO ROSCACHAPA CABEZA GOTA DE SEBO ZINCADO / VIS FILETÉE TÊTE DEMI RONDE ZINGUÉ
ROUND HEAD SELF TAPPING SCREW ZINC PLATED / VITI ZINCATE AUTOFIETTANTI CON TESTA A CROCE
PARAFUSO AUTO-ROSCANTE CABEÇA REDONDA ZINCADO

Ref. 0114

+ Medida / Dimensions / Size / Dimensioni / Medida

DIN 7983



↔	M-2,9	M-3,5	M-3,9	M-4,2	M-4,8	M-5,5	M-6,3
6,5	1,10
9,5	1,31	.	1,96	2,21	.	.	.
13	1,45	1,88	2,21	2,48	3,43	4,70	.
16	1,65	2,08	2,46	2,74	4,10	6,06	7,60
19	1,79	2,26	2,64	2,98	4,43	6,55	7,73
22	1,88	2,51	3,36	3,70	4,93	7,02	8,48
25	2,21	3,17	3,56	3,96	5,30	8,11	9,04
32	.	3,67	4,33	4,60	6,18	9,12	10,51
38	.	3,81	4,86	5,17	6,53	9,50	12,13
45	.	.	5,74	5,63	7,17	10,43	13,18
50	.	.	7,43	6,08	8,03	10,99	14,36
60	.	.	.	7,27	9,12	14,03	18,35
70	.	.	.	8,02	13,48	17,67	.
📦							
≤ 50	500	500	500	500	500	500	200
≥ 60	.	.	.	500	200	200	200

Price
x 100
units



**TORNILLO ROSCA DOBLE FILETE Y PUNTA ESPECIAL PERFORANTE - FOSFATADO / VIS DOUBLE FILET ET POINTE SPÉCIALE PERFORANTE - PHOSPHATE
DOUBLE THREAD AND SPECIAL DRILLING POINT - PHOSPHATIZED / VITI CON FILETTATURA DOPPIA E PUNTA SPECIALE PERFORANTE - FOSFATO
PARAFUSOS ROSCA DUPLO FIO E PONTA PERFORANTE - FOSFATO**

ES Tornillo para paneles de yeso, aislamientos, pladur. Fosfatados / Mortaja Phillips N°2 (Paso fino). Tornillos rosca doble filete y punta especial perforante. Para unir placas de yeso sobre perfiles metálicos.

FR Vis pour panneau de plâtre, isolement / promonta. Phosphate / Empreinte Phillips N°2 (Pas fin). Vis double filet et pointe spéciale perforante. Pour unir les plaques de plâtre sur des profilets métalliques.

EN Plaster panel screw insulation, plaster board. Phosphated / Phillips mortise N° 2 (Thin thread). Double thread and special drilling point specially used for joining panels on metallic profiles.

IT Vite a doppio filetto e punta perforante. Per pannelli in gesso/isolanti, taglio a croce. Passo fine. Per unire i piani in gesso ai profili metallici.

PT Parafuso para painéis de gesso, isolamentos, pladur. De fosfato / Encaixe Phillips No. 2 (Passo Fino). Parafusos rosca, duplo fio, ponta especial perforante. Para fixar placas de gesso sobre metal.

Ref. 0109

+ Medida / Dimensions / Size / Dimensioni / Medida



↔	3,5	4,2	4,8	
25	1,91	.	.	Price x 100 units
35	2,71	.	.	
45	3,18	.	.	
55	3,83	.	.	
90	.	.	19,40	
130	.	.	35,68	
≤ 55	1000	.	.	
60 - 100	.	250	250	
≥ 110	.	.	200	



**TORNILLO UNIÓN PLACA/PLACA-FOSFATADO / VIS UNION PLAQUE/PLAQUE-PHOSPHATE / SHEET-SHEET JOINING SCREW-PHOSPHATIZED
VITE PER GIUNZIONE PIASTRA/PIASTRA-FOSFATO / PARAFUSO DE FIXAÇÃO PLACA/PLACA-FOSFATO**

ES Tornillo unión placa / placa. Fosfatado. Mortaja Phillips N°2 (Paso ancho). Tornillo con rosca especial de paso ancho, adecuada para la perfecta sujeción entre placas de yeso.

FR Vis union plaque / plaque. Phosphate. Empreinte Phillips N°2 (Pas large). Vis avec filetage spécial de pas large, adapté pour la parfaite adhérence des plaques de plâtre.

EN Sheet / sheet joining screw. Phosphated. Phillips mortise N°2 (Wide thread). Ideal for perfect fastening between plaster sheets.

IT Viti per giunzioni piastra/piastra. Fosfatazione. Incisione Phillips N°2 (passo grosso). Vite con filetto speciale a passo grosso adeguata per una perfetta presa su placche in gesso.

PT Parafuso de fixação placa / placa. Fosfato. Encaixe Phillips n°2 (Passo largo). Parafuso com rosca especial de passo largo, adequado para a fixação perfeita entre placas de gesso.

Ref. 0110

+ Medida / Dimensions / Size / Dimensioni / Medida



↔	3,9	
25	2,06	Price x 100 units
45	3,51	
ALL	1000	



TORNILLOS PARA AGLOMERADO DE CABEZA AVELLANADA TORX / VIS À BOIS TÊTE FRAISÉE EMPREINTE TORX
 TORX CROSS RECESSED COUNTERSUNK HEAD CHIPBOARD SCREW / VITI TORX PER LEGNO TESTA SVASATA
 PARAFUSO AGLOMERADO CABEÇA ESCAREADA TORX

Ref. 0251

+ Medida / Mesures / Size / Dimenisione / Meça

DIN 7505A



↔	M-3 (T-10)	M-3,5 (T-15)	M-4 (T-20)	M-4,5 (T-25)	M-5 (T-25)	M-6 (T-30)
13	1,52
15	1,58	1,72	1,98	.	.	.
17	1,65	1,78	2,07	.	.	.
20	1,78	1,91	2,32	.	.	.
25	.	2,11	2,58	.	.	.
30	2,22	2,38	2,84	3,60	4,62	6,66
35	.	2,64	3,18	3,91	5,08	.
40	.	3,01	3,75	4,42	5,74	8,36
45	.	4,09	4,83	4,88	6,11	.
50	.	4,26	5,35	5,18	6,75	9,64
60	.	.	6,42	7,02	8,59	11,32
70	.	.	7,45	8,14	9,79	12,60
80	.	.	.	9,59	11,95	16,55
90	15,78	18,98
100	16,12	21,32
110	25,22
120	21,64	27,75
130	32,89
140	37,16
150	46,02
160	52,56
180	69,66
200	81,02
☐						
≤ 25	1000	1000	1000	500	200	200
40 - 60	500	500	500	500	200	200
≥ 70	.	.	.	200	200	200

Price
x 100
units

- ES **ROSCA ENTERA**
- FR **FILETAGE COMPLET**
- EN **FULL THREAD**
- IT **FILETTATURA TOTALE**
- PT **SEGMENTO INTEIRO**
-
- ES **ROSCA MEDIA CON FRESADO**
- FR **FILETAGE INTERMÉDIAIRE AVEC FRAISAGE**
- EN **PARTIAL THREAD WITH KNURLED SHANK RIBS**
- IT **FILETTATURA PARZIALE CON FILETTO FRESANTE**
- PT **ROSCA MÉDIA COM MOAGEM**

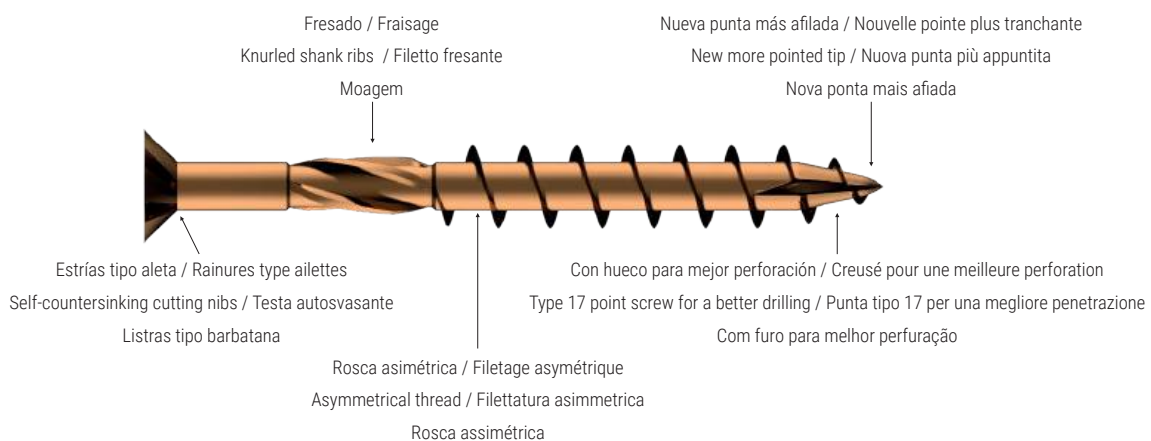

TORNILLOS PARA AGLOMERADO DE CABEZA AVELLANADA POZIDRIVE / VIS À BOIS TÊTE FRAISÉE EMPREINTE POZIDRIVE
 POZIDRIVE CROSS RECESSED COUNTERSUNK HEAD CHIPBOARD SCREW / VITI POZIDRIVE PER LEGNO TESTA SVASATA
 PARAFUSO AGLOMERADO CABEÇA ESCAREADA POZIDRIVE

Ref. 0250

+ Medida / Dimensions / Size / Dimensioni / Medida

DIN 7505A

ROSCA ENTERA

↔	M-2,5	M-3	M-3,5	M-4	M-4,5	M-5	M-6	
10	1,75	
12	1,85	
13	.	1,23	1,12	
16	1,97	1,35	1,44	1,68	.	.	.	
20	2,15	1,41	1,62	2,01	2,46	3,11	.	
25	2,49	1,64	1,83	2,13	2,92	3,77	.	
30	.	1,90	2,06	2,57	3,21	4,17	7,22	
35	.	.	2,39	2,75	3,48	4,53	7,50	
40	.	2,63	2,68	3,25	4,05	5,08	7,92	
45	.	.	2,97	3,54	4,35	5,59	8,45	
50	.	.	3,12	3,86	4,73	6,37	8,89	
60	.	.	.	4,60	5,74	7,37	10,36	
70	.	.	.	5,48	6,77	8,53	11,63	
80	8,62	9,88	13,38	Price x 100 units
90	11,37	17,37	
100	12,55	18,95	
110	24,16	
120	16,21	25,30	
130	27,16	
140	29,10	
150	32,98	
160	38,56	
180	52,47	
200	64,94	
⊞								
≤ 25	1000	1000	1000	1000	500	200	200	
40 - 60	.	500	500	500	500	200	200	
≥ 70	200	200	200	

ROSCA MEDIA



TORNILLO ENSAMBLAR NEGRO/ZINCADO / VIS ASSEMBLAGE NOIRE/ZINGUÉE / BLACK/ZINC PLATED BINDING SCREW
 VITI DI FISSAGGIO NERE/ZINCATE / PARAFUSO DE MONTAGEM PRETO/GALVANIZADO

Ref	⊞	⊞	⊞	Price x 100 units
0105 0550N	5 x 50 mm	300	16,00	
0105 0750N	7 x 50 mm	200	41,01	





Ref	⊞	⊞	⊞	Price x 100 units
0105 0550Z	5 x 50 mm	300	18,30	
0105 0750Z	7 x 50 mm	200	41,90	



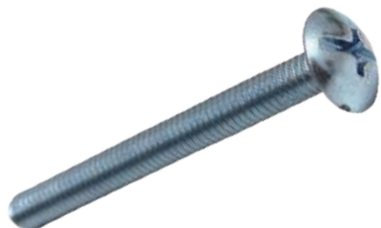

TORNILLO TIRADOR / VIS TIRAGE / FURNITURE HANDLE SCREW / VITI PER MANIGLIE CASSETTI / PARAFUSO DE MONTAGEM



Ref				
0105 1420	4 x 20 mm	500	5,70	Price x 100 units
0105 1430	4 x 30 mm	500	6,23	
0105 1440	4 x 40 mm	500	8,70	
0105 1450	4 x 50 mm	350	9,10	



TORNILLO TIRADOR DE CORTAR / VIS TIRAGE DE COUPE / TO BE CUT FURN. HANDLE SCREW
VITI DA TAGLIARE PER MANIGLIE CASSETTI / PARAFUSO DE MONTAGEM PARA CORTAR



Ref				
0105 1400	4 x 50 mm	40	30,67	Price x 100 units



HEMBRILLA ROSCADA CON TUERCA / CROCHET AVEC ÉCROU / SCREW HOOK WITH NUT
GANCI A VITE CON DADO / PARAFUSOS GANCHO COM PORCA



Ref				
1800 4301	M-3x25	100	47,41	
1800 4302	M-4x30	100	54,12	
1800 4303	M-5x40	100	60,61	
1800 4304	M-6x50	100	88,22	
1800 4305	M-6x90	100	100,43	
1800 4306	M-8x60	50	169,40	
1800 4307	M-10x70	25	217,80	
1800 4308	M-12x10	10	364,32	

CÁNCAMO ROSCADO CON TUERCA / CROCHET FERMÉ FILETÉ AVEC ÉCROU / SCREW EYE WITH NUT
GANCI A VITE AD OCCHIELLO CON DADO / OLHAL COM PORCA



Ref				
1800 4401	M-3x25	100	39,38	
1800 4402	M-4x30	100	45,10	
1800 4403	M-5x40	100	56,32	
1800 4404	M-6x50	100	84,81	
1800 4405	M-6x90	100	93,17	
1800 4406	M-8x60	50	134,64	
1800 4407	M-10x70	25	201,96	
1800 4408	M-12x100	10	350,35	



ALCAYATAS Y HEMBRILLAS ZINCADAS / CROCHET DE FIXATION / HOOK OF FIXATION
GANCI A RAMPINO / ESCÁPULAS E GANCHOS ZINCADOS

		B	L	
1,90 x 25	14 x 25	8	17	2,35
1,90 x 30	14 x 30	8	18	2,40
2,34 x 30	16 x 30	9	20	2,70
2,34 x 35	16 x 35	12	23	2,91
2,68 x 35	17 x 35	11	25	3,47
2,68 x 40	17 x 40	12	29	3,95
2,68 x 50	17 x 50	16	33	4,13
3,10 x 40	18 x 40	12	28	4,30
3,10 x 45	18 x 45	12	29	4,42
3,10 x 50	18 x 50	15	37	4,83
3,10 x 60	18 x 60	15	40	5,35
3,50 x 50	19 x 50	15	37	6,12
3,50 x 60	19 x 60	18	46	7,15
3,50 x 70	19 x 70	21	55	8,25
3,90 x 50	20 x 50	16	35	7,23
3,90 x 60	20 x 60	28	44	8,81
3,90 x 70	20 x 70	28	53	10,29

Price
x 100
units

		B	L	
3,90 x 80	20 x 80	28	63	12,17
3,90 x 90	20 x 90	30	72	13,90
4,25 x 60	21 x 60	21	45	11,50
4,25 x 70	21 x 70	23	53	12,20
4,25 x 80	21 x 80	21	60	13,35
4,25 x 90	21 x 90	28	70	15,20
4,25 x 100	21 x 100	25	80	16,80
4,70 x 80	22 x 80	23	59	16,70
4,70 x 90	22 x 90	24	70	18,30
4,70 x 100	22 x 100	28	79	19,70
4,70 x 120	22 x 120	32	98	22,50
5,50 x 90	23 x 90	.	.	.
5,50 x 100	23 x 100	34	80	30,22
5,50 x 110	23 x 110	.	.	.
5,50 x 130	23 x 130	36	99	33,00
5,50 x 150	23 x 150	.	.	.

Price
x 100
units

ALCAYATA ROSCA / HOOK OF FIXATION

Ref. 0106

+ Medida / Dimensions / Size / Dimensioni / Medida

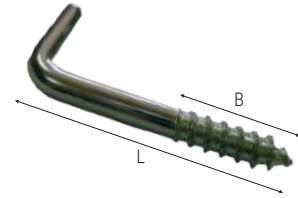

		B	L	
1,90 x 25	14 x 25	10	21	2,36
2,34 x 30	16 x 30	12	25	2,91
2,34 x 35	16 x 35	8	23	2,94
2,68 x 35	17 x 35	8	26	.
2,68 x 40	17 x 40	14	29	4,50
2,68 x 50	17 x 50	12	38	5,12
3,10 x 40	18 x 40	15	30	6,23
3,10 x 50	18 x 50	20	36	5,60
3,10 x 60	18 x 60	17	43	6,05
3,50 x 50	19 x 50	18	34	7,96
3,50 x 60	19 x 60	22	42	7,80
3,50 x 70	19 x 70	24	50	9,50
3,90 x 50	20 x 50	19	34	9,43
3,90 x 60	20 x 60	21	42	11,32
3,90 x 70	20 x 70	26	47	11,65

Price
x 100
units

		B	L	
3,90 x 80	20 x 80	30	53	12,90
3,90 x 90	20 x 90	24	65	13,60
4,25 x 70	21 x 70	23	48	14,90
4,25 x 80	21 x 80	28	54	17,00
4,25 x 90	21 x 90	32	58	17,70
4,25 x 100	21 x 100	37	60	18,51
4,70 x 80	22 x 80	21	66	20,30
4,70 x 90	22 x 90	.	.	.
4,70 x 100	22 x 100	26	77	23,40
4,70 x 120	22 x 120	33	88	26,10
5,50 x 90	23 x 90	28	79	31,90
5,50 x 100	23 x 100	.	.	.
5,50 x 110	23 x 110	.	.	.
5,50 x 130	23 x 130	36	96	34,30
5,50 x 150	23 x 150	37	104	37,00

Price
x 100
units

HEMBRILLA ABIERTA / OPEN HOOK

Ref. 0108

+ Medida / Dimensions / Size / Dimensioni / Medida

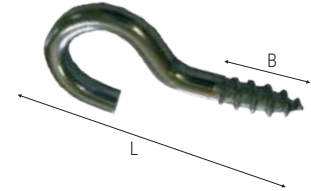

		B	L	
1,90 x 25	14 x 25	10	21	2,40
1,90 x 30	14 x 30	6	20	2,49
2,34 x 30	16 x 30	12	25	2,91
2,34 x 35	16 x 35	7	22	3,00
2,68 x 35	17 x 35	10	25	3,90
2,68 x 40	17 x 40	14	29	4,35
2,68 x 50	17 x 50	11	34	4,83
3,10 x 40	18 x 40	15	30	4,97
3,10 x 50	18 x 50	20	36	5,48
3,10 x 60	18 x 60	15	39	5,86
3,50 x 50	19 x 50	18	34	7,60
3,50 x 60	19 x 60	22	42	7,81
3,50 x 70	19 x 70	24	50	8,64
3,90 x 50	20 x 50	19	34	11,10
3,90 x 60	20 x 60	21	42	10,20
3,90 x 70	20 x 70	26	47	11,10

Price
x 100
units

		B	L	
3,90 x 80	20 x 80	30	53	12,45
3,90 x 90	20 x 90	23	59	12,95
4,25 x 60	21 x 60	21	46	13,25
4,25 x 70	21 x 70	23	48	14,70
4,25 x 80	21 x 80	28	54	15,40
4,25 x 90	21 x 90	32	58	16,20
4,25 x 100	21 x 100	37	60	17,35
4,70 x 80	22 x 80	19	50	18,50
4,70 x 100	22 x 100	25	63	20,50
4,70 x 120	22 x 120	36	74	22,50
5,50 x 90	23 x 90	24	68	31,50
5,50 x 100	23 x 100	.	.	.
5,50 x 110	23 x 110	32	76	34,21
5,50 x 130	23 x 130	37	92	37,50
5,50 x 150	23 x 150	.	.	.

Price
x 100
units

HEMBRILLA CERRADA / CLOSED HOOK

Ref. 0107

+ Medida / Dimensions / Size / Dimensioni / Medida



TORNILLO CABEZA PLANA TORX ANCLAJE ESPECIAL HORMIGÓN. ZINCADO BLANCO SIN CROMO 6
VIS TÊTE PLATE TORX ENCRAGE SPÉCIAL BÉTON. ZINGUÉ BLANC SANS CHROME 6
SCREW FOR CONCRETE (PLUGS ARE NOT NECESSARY). ZINC PLATED WHITE WITHOUT CHROME 6
VITE BIANCA TORX A TESTA PIANA ZINCATA E SENZA CROMO 6
PARAFUSO CABEÇA PLANA TORX ANCORAGEM ESPECIAL BETÃO. ZINCADO BRANCO SEM CROMO 6

Ref. 0252
+ Medida / Dimensions / Size / Dimensiuni / Medida

ES TORNILLO PARA ANCLAJE EN HORMIGÓN. Sin necesidad de utilizar tacos, se fija en una simple operación de taladro y atornillado. La mortaja Torx, presenta la mayor capacidad de absorber al máximo el par de apriete necesario, además de no producir daño alguno sobre la cabeza. Zincado blanco sin cromo 6. Proceso nuevo de zincado que supera en cuatro veces la resistencia a la corrosión del zincado blanco normal y en dos veces al zincado bricomatado.

FR VIS A BETON, SANS NECESSITE DE CHEVILLE. Elle se fixe par une simple opération de perçage et de vissage, sans avoir à utiliser de cheville. L'empreinte Torx présente la meilleure capacité d'absorption du couple de serrage nécessaire, et en outre n'endommage pas la tête de vis. Zingué blanc sans chrome 6. Nouveau processus zingué qui améliore 4 fois la résistance à la corrosion du zingué blanc normal et au zingué bichromate.

EN SCREW FOR CONCRETE. Plugs are not necessary, simple fixing just by drilling and screwing. Its Torx mortise increases its capacity of absorption of tightening, and it does not hurt the head of the screw. White zinc without chrome 6. New zinc process which is four times better in a rust resistance than usual white zinc coating and two times better than bichromate zinc coating.

IT VITI PER CALCESTRUZZO. Facili da fissare attraverso una semplice operazione di perforazione e avvitamento. Il Torx presenta un'aumentata capacità d'assorbimento durante l'avvitamento senza procurare danni alla testa della vite. Zincato senza cromo 6. Nuovo processo di zincatura quattro volte più resistente alla corrosione dello zincato normale e due volte più resistente dello zinco bicomato.

PT PARAFUSO PARA BETÃO. Não são necessárias buchas, fixação através da perfuração simples e aparafusar. Seu Torx encaixe aumenta a sua capacidade de absorção de aperto, e não faz dano ao parafuso. Zinco branco sem cromo 6. Processo de zinco novo, que é quatro vezes melhor em uma resistência à corrosão que o zinco branco habitual revestimento e duas vezes melhor do que o revestimento de zinco bichromate.

Ref						
0252 7560	7,5 x 60	60 mm	T30	200	37,62	Price x 100 units
0252 7580	7,5 x 80	80 mm	T30	200	48,18	
0252 75100	7,5 x 100	100 mm	T30	100	64,02	
0252 75120	7,5 x 120	120 mm	T30	100	79,86	
0252 75150	7,5 x 150	150 mm	T30	100	112,86	
0252 75180	7,5 x 180	180 mm	T30	100	165,00	

TORNILLO INVOLABLE TORX - 30 ZINCADO / VIS INVOLABLE TORX - 30 ZINGUÉ / INVOLABLE SCREW TORX - 30 ZINC PLATED
VITE INVOLABLE TORX - 30 ZINCATO / PARAFUSO INVOLÁVEL TORX 30 ZINCADO

Ref. 0255
+ Medida / Dimensions / Size / Dimensiuni / Medida

ES Fabricados en acero especial endurecido. Colocación por percusión. El tornillo involable Torx-30, está especialmente diseñado para la utilización con taco de nylon o roscado directamente sobre madera. Especialmente recomendado para fijación de rejas contra actos vandálicos, herrajes en sitios que requieran cierta seguridad o mobiliario urbano. Una vez atornillado se coloca el tapón de Zamak sobre la mortaja de la cabeza con un simple martillazo.

FR Fabriquées en acier spécial durci par traitement Thermique. Avec un simple coup de marteau. La vis involable Torx-30, est spécialement conçue pour l'utilisation avec une cheville de nylon ou pour être vissé directement sur le bois. Spécialement recommandée pour la fixation de grilles de protection contre des actes de vandalisme, pour des ferronneries dans des endroits qui requièrent une certaine sécurité ou sur du mobilier urbain. Une fois vissée, on place le cache vis Zamak sur la vis avec un simple coup de marteau.

EN Made of a special hardened steel. Percussion fixing. Inviolable screw Torx-30 is specially designed to be used with nylon fixing plugs or directly to the wood. Specially recommended for fixing bars against vandalic acts or in cases of safety devices. Once the screw is screwed, place the Zamak plug over its head with a simple hammer blow.

IT Fabbriato in acciaio indurito trattato termicamente. Collocazione attraverso un semplice colpo di martello. La vite involabile, Torx-30, è specificamente progettata per essere utilizzata in tasselli di nylon e per essere avvitata direttamente nel legno. E' caldamente consigliata per il fissaggio di grate contro atti vandalici. Una volta fissata, con un semplice colpo di martello si colloca la placca in Zamak nell'incavo presente nella testa della stessa.

PT Feitos de aço temperado especial començaixe. Colocação por percussão. O involável parafuso Torx-30, foi especialmente projetado para uso com bucha de nylon com rosca ou diretamente na madeira. Especialmente recomendado para fixar as barras de vandalismo, acessórios ou adaptadores sites que exigem determinada segurança ou mobiliário urbano. Uma vez aparafusado é colocada a tampa de Zamak sobre o encaixe da cabeça com uma simples martelada.

Ref						
0255 0750	7 x 50	T-30	16 mm	100	35,53	Price x 100 units
0255 0760	7 x 60	T-30	16 mm	100	39,16	
0255 0770	7 x 70	T-30	16 mm	100	41,58	
0255 0780	7 x 80	T-30	16 mm	100	42,24	
0255 0790	7 x 90	T-30	16 mm	100	45,55	

PUNTA HIERRO CABEZA PLANA / POINTE FER TÊTE PLATE / IRON TIP FLAT HEAD / PUNTA IN FERRO A TESTA PIATTA / PONTA FERRO CABEÇA CHATA



Ref				
0120 2760	2,7 x 60 mm	2,5 kg	23,20	Price x 2,5 kg
0120 3060	3 x 60 mm	2,5 kg	23,20	
0120 3070	3,4 x 70 mm	2,5 kg	23,20	
0120 3480	3,4 x 80 mm	2,5 kg	23,20	
0120 4090	4 x 90 mm	2,5 kg	23,20	
0120 44100	4,4 x 100 mm	2,5 kg	23,20	
0120 54120	5,4 x 120 mm	2,5 kg	23,20	



PUNTA ACERO CABEZA PLANA ZINCADA / POINTE ACIER TÊTE PLATE ZINGUÉE / STEEL TIP ZINCPLATED FLAT HEAD / PUNTA IN ACCIAIO CON TESTA PIATTA ZINCATA / PONTA DE AÇO, CABEÇA CHATA, GALVANIZADO



Ref				
0123 2530	2,5 x 30 mm	500	2,21	Price x 100 units
0123 2550	2,5 x 50 mm	300	3,65	
0123 2950	2,9 x 50 mm	300	4,71	
0123 2960	2,9 x 60 mm	300	5,78	
0123 3440	3,4 x 40 mm	200	5,40	
0123 3450	3,4 x 50 mm	200	6,42	
0123 3460	3,4 x 60 mm	100	8,50	
0123 3470	3,4 x 70 mm	100	9,01	
0123 3480	3,4 x 80 mm	100	9,95	



PUNTA DE ACERO CÓNICA COBREIZADA / POINTE ACIER CONIQUE CUIVRE / COPPERPLATED ST.TIP CONIC HEAD / PUNTA CONICA IN ACCIAIO CON RAMATURA / PONTA DE AÇO CÔNICA COBREÁDO



Ref				
0121 1520	1,5 x 20 mm	1000	1,23	Price x 100 units
0121 2025	2,0 x 25 mm	500	1,70	
0121 2030	2,0 x 30 mm	500	1,93	
0121 2035	2,0 x 35 mm	500	2,34	
0121 2040	2,0 x 40 mm	500	2,44	
0121 2045	2,0 x 45 mm	500	2,87	
0121 2050	2,0 x 50 mm	500	3,05	



PUNTA DE ACERO CABEZA CÓNICA ZINCADA / POINTE ACIER ZINGUÉE TÊTE CONIQUE / ST.TIP ZINCPLATED CONIC HEAD / PUNTA IN ACCIAIO ZINCATO CON TESTA CONICA / PONTA DE AÇO, GALVANIZADO, CABEÇA CÔNICA





Ref				
0122 1520	1,5 x 20 mm	1000	1,27	Price x 100 units
0122 2025	2,0 x 25 mm	500	1,47	
0122 2030	2,0 x 30 mm	500	1,61	
0122 2035	2,0 x 35 mm	500	2,34	
0122 2040	2,0 x 40 mm	500	2,44	
0122 2045	2,0 x 45 mm	500	2,87	
0122 2050	2,0 x 50 mm	500	3,13	

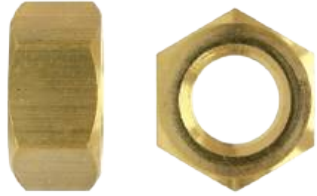

DIN 934 LATÓN / LAITON / BRASS / OTTONE / LATÃO

DIN 934





Ref	M			Price x 100 units
0032 0003L	M-3	200	9,85	
0032 0004L	M-4	100	13,41	
0032 0005L	M-5	50	17,26	
0032 0006L	M-6	50	23,76	
0032 0008L	M-8	50	57,60	
0032 00010L	M-10	20	103,68	
0032 00012L	M-12	20	168,56	
0032 00014L	M-14	10	260,91	
0032 00016L	M-16	10	347,56	
0032 00018L	M-18	5	495,86	
0032 00020L	M-20	5	743,93	

DIN 1587 LATÓN / LAITON / BRASS / OTTONE / LATÃO

DIN 1587





Ref	M			Price x 100 units
0033 0003L	M-3	100	37,04	
0033 0004L	M-4	100	63,84	
0033 0005L	M-5	100	73,02	
0033 0006L	M-6	50	75,44	
0033 0008L	M-8	50	130,61	
0033 0010L	M-10	25	277,08	
0033 0012L	M-12	25	437,84	
0033 0014L	M-14	10	559,28	
0033 0016L	M-16	10	783,42	
0033 0018L	M-18	5	1356,44	
0033 0020L	M-20	5	1787,75	

DIN 125 LATÓN / LAITON / BRASS / OTTONE / LATÃO

DIN 125





Ref	M			Price x 100 units
0052 0003L	M-3	100	4,62	
0052 0004L	M-4	100	5,25	
0052 0005L	M-5	100	7,00	
0052 0006L	M-6	100	11,67	
0052 0008L	M-8	50	18,68	
0052 0010L	M-10	50	30,35	
0052 0012L	M-12	25	58,38	
0052 0014L	M-14	25	77,06	
0052 0016L	M-16	20	102,74	
0052 0018L	M-18	5	161,12	
0052 0020L	M-20	5	186,80	

DIN 975 LATÓN / LAITON / BRASS / OTTONE / LATÃO

DIN 975





Ref	M		
0040 0003L	M-3	10	10,18
0040 0004L	M-4	5	12,74
0040 0005L	M-5	5	16,67
0040 0006L	M-6	5	19,32
0040 0008L	M-8	5	33,15
0040 0010L	M-10	3	49,31
0040 0012L	M-12	2	73,25
0040 0014L	M-14	2	105,71
0040 0016L	M-16	2	113,19
0040 0018L	M-18	2	160,88
0040 0020L	M-20	2	209,59

TORNILLO DIN 931 / VIS DIN 931 / SCREW DIN 931 / VITI DIN 931 / PARAFUSO DIN 931

DIN 931



INOX A2	INOX A4	M		INOX A2	INOX A4	M	
0026 0530	0026 0530A4	M-5 x 30	100	0026 1250	0026 1250A4	M-12 x 50	50
0026 0540	0026 0540A4	M-5 x 40	100	0026 1260	0026 1260A4	M-12 x 60	50
0026 0550	0026 0550A4	M-5 x 50	100	0026 1270	0026 1270A4	M-12 x 70	50
0026 0560	0026 0560A4	M-5 x 60	100	0026 1280	0026 1280A4	M-12 x 80	50
0026 0570	.	M-5 x 70	100	0026 1290	0026 1290A4	M-12 x 90	25
0026 06100	0026 06100A4	M-6 x 100	100	0026 14100	0026 14100A4	M-14 x 100	25
0026 06120	.	M-6 x 120	100	0026 14110	.	M-14 x 110	25
0026 06130	.	M-6 x 130	50	0026 14120	0026 14120A4	M-14 x 120	25
0026 0630	0026 0630A4	M-6 x 30	100	0026 14130	.	M-14 x 130	10
0026 0640	0026 0640A4	M-6 x 40	100	0026 14140	.	M-14 x 140	10
0026 0650	0026 0650A4	M-6 x 50	100	0026 14150	.	M-14 x 150	10
0026 0660	0026 0660A4	M-6 x 60	100	0026 1450	0026 1450A4	M-14 x 50	25
0026 0670	0026 0670A4	M-6 x 70	100	0026 1460	0026 1460A4	M-14 x 60	25
0026 0680	0026 0680A4	M-6 x 80	100	0026 1470	0026 1470A4	M-14 x 70	25
0026 0690	0026 0690A4	M-6 x 90	100	0026 1480	0026 1480A4	M-14 x 80	25
0026 08100	0026 08100A4	M-8 x 100	50	0026 1490	0026 1490A4	M-14 x 90	25
0026 08110	.	M-8 x 110	50	0026 16100	0026 16100A4	M-16 x 100	25
0026 08120	.	M-8 x 120	50	0026 16110	.	M-16 x 110	25
0026 0830	0026 0830A4	M-8 x 30	100	0026 16120	0026 16120A4	M-16 x 120	25
0026 0840	0026 0840A4	M-8 x 40	100	0026 16130	.	M-16 x 130	10
0026 0850	0026 0850A4	M-8 x 50	100	0026 16140	.	M-16 x 140	10
0026 0860	0026 0860A4	M-8 x 60	100	0026 16150	.	M-16 x 150	10
0026 0870	0026 0870A4	M-8 x 70	50	0026 16160	.	M-16 x 160	10
0026 0880	0026 0880A4	M-8 x 80	50	0026 1650	0026 1650A4	M-16 x 50	25
0026 0890	0026 0890A4	M-8 x 90	50	0026 1660	0026 1660A4	M-16 x 60	25
0026 10100	0026 10100A4	M-10 x 100	50	0026 1670	0026 1670A4	M-16 x 70	25
0026 10110	.	M-10 x 110	50	0026 1680	0026 1680A4	M-16 x 80	25
0026 10120	.	M-10 x 120	50	0026 1690	0026 1690A4	M-16 x 90	25
0026 10130	.	M-10 x 130	25	0026 18100	0026 18100A4	M-18 x 100	5
0026 1040	0026 1040A4	M-10 x 40	50	0026 18120	0026 18120A4	M-18 x 120	5
0026 1050	0026 1050A4	M-10 x 50	50	0026 18140	.	M-18 x 140	5
0026 1060	0026 1060A4	M-10 x 60	50	0026 1870	0026 1870A4	M-18 x 70	10
0026 1070	0026 1070A4	M-10 x 70	50	0026 1880	0026 1880A4	M-18 x 80	10
0026 1080	0026 1080A4	M-10 x 80	50	0026 1890	0026 1890A4	M-18 x 90	10
0026 1090	0026 1090A4	M-10 x 90	50	0026 20100	0026 20100A4	M-20 x 100	5
0026 12100	0026 12100A4	M-12 x 100	25	0026 20120	0026 20120A4	M-20 x 120	5
0026 12110	.	M-12 x 110	25	0026 20130	.	M-20 x 130	5
0026 12120	0026 12120A4	M-12 x 120	25	0026 20140	.	M-20 x 140	5
0026 12130	.	M-12 x 130	25	0026 2080	0026 2080A4	M-20 x 80	10
0026 12140	.	M-12 x 140	25	0026 2090	0026 2090A4	M-20 x 90	10
0026 1240	0026 1240A4	M-12 x 40	50	0026 22140	.	M-22 x 140	1
0026 1245	.	M-12 x 45	50	0026 30120	.	M-30 x 120	1



TORNILLO DIN 933 / VIS DIN 933 / SCREW DIN 933 / VITI DIN 933 / PARAFUSO DIN 933

INOX A2	INOX A4	M	
0025 0306	0025 0306A4	M-3 x 6	200
0025 0308	.	M-3 x 8	200
0025 0310	0025 0310A4	M-3 x 10	200
0025 0312	.	M-3 x 12	200
0025 0316	0025 0316A4	M-3 x 16	200
0025 0320	0025 0320A4	M-3 x 20	200
0025 0325	.	M-3 x 25	200
0025 0330	0025 0330A4	M-3 x 30	100
0025 0335	.	M-3 x 35	100
0025 0340	0025 0340A4	M-3 x 40	100
0025 0406	0025 0406A4	M-4 x 6	200
0025 0408	.	M-4 x 8	200
0025 0410	0025 0410A4	M-4 x 10	200
0025 0412	.	M-4 x 12	200
0025 0416	0025 0416A4	M-4 x 16	200
0025 0420	0025 0420A4	M-4 x 20	200
0025 0425	.	M-4 x 25	200
0025 0430	0025 0430A4	M-4 x 30	100
0025 0435	.	M-4 x 35	100
0025 0440	0025 0440A4	M-4 x 40	100
0025 0445	.	M-4 x 45	100
0025 0450	0025 0450A4	M-4 x 50	50
0025 0460	.	M-4 x 60	50
0025 0508	.	M-5 x 8	200
0025 0510	0025 0510A4	M-5 x 10	200
0025 0512	.	M-5 x 12	200
0025 0516	0025 0516A4	M-5 x 16	200
0025 0520	0025 0520A4	M-5 x 20	200
0025 0525	0025 0525A4	M-5 x 25	200
0025 0530	0025 0530A4	M-5 x 30	200
0025 0535	.	M-5 x 35	100
0025 0540	0025 0540A4	M-5 x 40	100
0025 0545	.	M-5 x 45	100
0025 0550	0025 0550A4	M-5 x 50	50
0025 0560	0025 0560A4	M-5 x 60	50
0025 0570	.	M-5 x 70	50
0025 0580	.	M-5 x 80	50
0025 0608	.	M-6 x 8	200
0025 0610	0025 0610A4	M-6 x 10	200
0025 06100	.	M-6 x 100	25
0025 0612	.	M-6 x 12	200
0025 0616	0025 0616A4	M-6 x 16	200
0025 0620	0025 0620A4	M-6 x 20	200
0025 0625	0025 0625A4	M-6 x 25	200
0025 0630	0025 0630A4	M-6 x 30	200
0025 0635	.	M-6 x 35	100
0025 0640	0025 0640A4	M-6 x 40	100
0025 0645	.	M-6 x 45	100
0025 0650	0025 0650A4	M-6 x 50	50
0025 0660	0025 0660A4	M-6 x 60	50
0025 0665	0025 0665A4	M-6 x 65	50
0025 0670	0025 0670A4	M-6 x 70	50
0025 0680	.	M-6 x 80	50
0025 0690	.	M-6 x 90	25
0025 0810	0025 0810A4	M-8 x 10	100
0025 08100	.	M-8 x 100	50
0025 08110	.	M-8 x 110	25
0025 0812	.	M-8 x 12	100
0025 08120	.	M-8 x 120	25
0025 08130	.	M-8 x 130	10
0025 08140	.	M-8 x 140	10
0025 0816	0025 0816A4	M-8 x 16	100
0025 0820	0025 0820A4	M-8 x 20	100
0025 0825	0025 0825A4	M-8 x 25	100
0025 0830	0025 0830A4	M-8 x 30	100
0025 0835	.	M-8 x 35	100
0025 0840	0025 0840A4	M-8 x 40	100
0025 0845	.	M-8 x 45	100

INOX A2	INOX A4	M	
0025 0850	0025 0850A4	M-8 x 50	100
0025 0855	.	M-8 x 55	50
0025 0860	0025 0860A4	M-8 x 60	50
0025 0865	.	M-8 x 65	50
0025 0870	0025 0870A4	M-8 x 70	50
0025 0880	0025 0880A4	M-8 x 80	50
0025 0890	.	M-8 x 90	25
0025 10100	0025 10100A4	M-10 x 100	25
0025 10110	.	M-10 x 110	10
0025 1012	.	M-10 x 12	100
0025 10120	0025 10120A4	M-10 x 120	10
0025 1016	0025 1016A4	M-10 x 16	100
0025 1020	0025 1020A4	M-10 x 20	100
0025 1025	0025 1025A4	M-10 x 25	100
0025 1030	0025 1030A4	M-10 x 30	100
0025 1035	.	M-10 x 35	100
0025 1040	0025 1040A4	M-10 x 40	100
0025 1045	.	M-10 x 45	100
0025 1050	0025 1050A4	M-10 x 50	50
0025 1060	0025 1060A4	M-10 x 60	50
0025 1070	0025 1070A4	M-10 x 70	25
0025 1080	0025 1080A4	M-10 x 80	25
0025 1090	0025 1090A4	M-10 x 90	25
0025 12100	0025 12100A4	M-12 x 100	25
0025 12110	.	M-12 x 110	10
0025 12120	0025 12120A4	M-12 x 120	10
0025 1216	0025 1216A4	M-12 x 16	50
0025 1220	0025 1220A4	M-12 x 20	50
0025 1225	0025 1225A4	M-12 x 25	50
0025 1230	0025 1230A4	M-12 x 30	50
0025 1235	.	M-12 x 35	50
0025 1240	0025 1240A4	M-12 x 40	50
0025 1245	.	M-12 x 45	50
0025 1250	0025 1250A4	M-12 x 50	50
0025 1260	0025 1260A4	M-12 x 60	50
0025 1265	.	M-12 x 65	50
0025 1270	0025 1270A4	M-12 x 70	50
0025 1280	0025 1280A4	M-12 x 80	25
0025 1290	0025 1290A4	M-12 x 90	25
0025 14100	0025 14100A4	M-14 x 100	10
0025 14110	.	M-14 x 110	10
0025 14120	.	M-14 x 120	5
0025 1420	0025 1420A4	M-14 x 20	25
0025 1425	0025 1425A4	M-14 x 25	25
0025 1430	0025 1430A4	M-14 x 30	25
0025 1435	.	M-14 x 35	25
0025 1440	0025 1440A4	M-14 x 40	25
0025 1445	.	M-14 x 45	25
0025 1450	0025 1450A4	M-14 x 50	25
0025 1460	0025 1460A4	M-14 x 60	25
0025 1470	0025 1470A4	M-14 x 70	25
0025 1480	0025 1480A4	M-14 x 80	10
0025 1490	0025 1490A4	M-14 x 90	10
0025 16100	0025 16100A4	M-16 x 100	10
0025 16110	.	M-16 x 110	10
0025 16120	0025 16120A4	M-16 x 120	5
0025 16130	0025 16130A4	M-16 x 130	5
0025 16140	.	M-16 x 140	5
0025 1620	0025 1620A4	M-16 x 20	25
0025 1625	0025 1625A4	M-16 x 25	25
0025 1630	0025 1630A4	M-16 x 30	25
0025 1635	.	M-16 x 35	25
0025 1640	0025 1640A4	M-16 x 40	25
0025 1645	.	M-16 x 45	25
0025 1650	0025 1650A4	M-16 x 50	25
0025 1655	.	M-16 x 55	25
0025 1660	0025 1660A4	M-16 x 60	25
0025 1670	0025 1670A4	M-16 x 70	25

DIN 933





INOX A2	INOX A4	M	
0025 1680	0025 1680A4	M-16 x 80	10
0025 1690	0025 1690A4	M-16 x 90	10
0025 18100	0025 18100A4	M-18 x 100	5
0025 18110	.	M-18 x 110	5
0025 18120	.	M-18 x 120	5
0025 1830	0025 1830A4	M-18 x 30	25
0025 1840	0025 1840A4	M-18 x 40	25
0025 1850	0025 1850A4	M-18 x 50	10
0025 1860	0025 1860A4	M-18 x 60	10
0025 1870	0025 1870A4	M-18 x 70	10
0025 1880	0025 1880A4	M-18 x 80	10
0025 1890	0025 1890A4	M-18 x 90	10
0025 20100	0025 20100A4	M-20 x 100	5
0025 20110	.	M-20 x 110	5
0025 20120	.	M-20 x 120	5
0025 20130	.	M-20 x 130	5
0025 20140	.	M-20 x 140	5
0025 20150	.	M-20 x 150	5
0025 2030	0025 2030A4	M-20 x 30	10
0025 2040	0025 2040A4	M-20 x 40	10
0025 2045	.	M-20 x 45	10
0025 2050	0025 2050A4	M-20 x 50	10
0025 2060	0025 2060A4	M-20 x 60	10
0025 2070	0025 2070A4	M-20 x 70	10
0025 2080	0025 2080A4	M-20 x 80	10
0025 2090	0025 2090A4	M-20 x 90	10
0025 22100	0025 22100A4	M-22 x 100	1
0025 22110	.	M-22 x 110	1
0025 22120	.	M-22 x 120	1
0025 2250	0025 2250A4	M-22 x 50	5
0025 2260	0025 2260A4	M-22 x 60	5
0025 2270	0025 2270A4	M-22 x 70	5
0025 2280	0025 2280A4	M-22 x 80	5
0025 2290	0025 2290A4	M-22 x 90	5
0025 24100	0025 24100A4	M-24 x 100	1
0025 2450	0025 2450A4	M-24 x 50	5
0025 2460	0025 2460A4	M-24 x 60	5
0025 2470	0025 2470A4	M-24 x 70	5
0025 2480	0025 2480A4	M-24 x 80	5
0025 2490	0025 2490A4	M-24 x 90	5
0025 27100	.	M-27 x 100	1
0025 27110	.	M-27 x 110	1

TORNILLO ALLEN / VIS ALLEN / SCREW ALLEN / VITI ALLEN / PARAFUSO ALLEN

DIN 912



INOX A2	INOX A4	M		INOX A2	INOX A4	M	
0023 0306	0023 0306A4	M-3 x 6	200	0023 0825	0023 0825A4	M-8 x 25	100
0023 0308	0023 0308A4	M-3 x 8	200	0023 0830	0023 0830A4	M-8 x 30	100
0023 0310	0023 0310A4	M-3 x 10	200	0023 0835	.	M-8 x 35	100
0023 0312	0023 0312A4	M-3 x 12	200	0023 0840	0023 0840A4	M-8 x 40	100
0023 0316	0023 0316A4	M-3 x 16	200	0023 0845	.	M-8 x 45	100
0023 0320	0023 0320A4	M-3 x 20	200	0023 0850	0023 0850A4	M-8 x 50	100
0023 0325	.	M-3 x 25	200	0023 0860	0023 0860A4	M-8 x 60	50
0023 0330	0023 0330A4	M-3 x 30	200	0023 0870	0023 0870A4	M-8 x 70	50
0023 0335	.	M-3 x 35	200	0023 0880	0023 0880A4	M-8 x 80	50
0023 0340	0023 0340A4	M-3 x 40	200	0023 0890	.	M-8 x 90	50
0023 0350	.	M-3 x 50	200	0023 10100	0023 10100A4	M-10 x 100	25
0023 0406	0023 0406A4	M-4 x 6	200	0023 10120	.	M-10 x 120	10
0023 0408	.	M-4 x 8	200	0023 1016	0023 1016A4	M-10 x 16	100
0023 0410	0023 0410A4	M-4 x 10	200	0023 1020	0023 1020A4	M-10 x 20	100
0023 0412	.	M-4 x 12	200	0023 1025	0023 1025A4	M-10 x 25	50
0023 0416	0023 0416A4	M-4 x 16	200	0023 1030	0023 1030A4	M-10 x 30	50
0023 0420	0023 0420A4	M-4 x 20	200	0023 1035	.	M-10 x 35	50
0023 0425	.	M-4 x 25	200	0023 1040	0023 1040A4	M-10 x 40	50
0023 0430	0023 0430A4	M-4 x 30	200	0023 1045	.	M-10 x 45	50
0023 0435	.	M-4 x 35	200	0023 1050	0023 1050A4	M-10 x 50	50
0023 0440	0023 0440A4	M-4 x 40	200	0023 1060	0023 1060A4	M-10 x 60	25
0023 0445	.	M-4 x 45	100	0023 1070	0023 1070A4	M-10 x 70	25
0023 0450	0023 0450A4	M-4 x 50	100	0023 1080	0023 1080A4	M-10 x 80	25
0023 0460	.	M-4 x 60	100	0023 1090	0023 1090A4	M-10 x 90	25
0023 0506	0023 0506A4	M-5 x 6	200	0023 12100	0023 12100A4	M-12 x 100	25
0023 0508	.	M-5 x 8	200	0023 12120	.	M-12 x 120	10
0023 0510	0023 0510A4	M-5 x 10	200	0023 1216	0023 1216A4	M-12 x 16	50
0023 0512	.	M-5 x 12	200	0023 1220	0023 1220A4	M-12 x 20	50
0023 0516	0023 0516A4	M-5 x 16	200	0023 1225	0023 1225A4	M-12 x 25	50
0023 0520	0023 0520A4	M-5 x 20	200	0023 1230	0023 1230A4	M-12 x 30	50
0023 0525	.	M-5 x 25	200	0023 1235	.	M-12 x 35	50
0023 0530	0023 0530A4	M-5 x 30	200	0023 1240	0023 1240A4	M-12 x 40	50
0023 0535	.	M-5 x 35	100	0023 1245	.	M-12 x 45	50
0023 0540	0023 0540A4	M-5 x 40	100	0023 1250	0023 1250A4	M-12 x 50	25
0023 0545	.	M-5 x 45	100	0023 1260	0023 1260A4	M-12 x 60	25
0023 0550	0023 0550A4	M-5 x 50	100	0023 1270	0023 1270A4	M-12 x 70	25
0023 0560	0023 0560A4	M-5 x 60	100	0023 1280	0023 1280A4	M-12 x 80	25
0023 0570	.	M-5 x 70	100	0023 1290	0023 1290A4	M-12 x 90	25
0023 0580	.	M-5 x 80	100	0023 14100	0023 14100A4	M-14 x 100	10
0023 0590	.	M-5 x 90	100	0023 1420	0023 1420A4	M-14 x 20	25
0023 0606	0023 0606A4	M-6 x 6	100	0023 1425	0023 1425A4	M-14 x 25	25
0023 0610	0023 0610A4	M-6 x 10	100	0023 1430	0023 1430A4	M-14 x 30	25
0023 06100	0023 06100A4	M-6 x 100	50	0023 1435	.	M-14 x 35	25
0023 0612	.	M-6 x 12	100	0023 1440	0023 1440A4	M-14 x 40	25
0023 0616	0023 0616A4	M-6 x 16	100	0023 1445	.	M-14 x 45	25
0023 0620	0023 0620A4	M-6 x 20	100	0023 1450	0023 1450A4	M-14 x 50	25
0023 0625	0023 0625A4	M-6 x 25	100	0023 1460	0023 1460A4	M-14 x 60	10
0023 0630	0023 0630A4	M-6 x 30	100	0023 1470	0023 1470A4	M-14 x 70	10
0023 0635	.	M-6 x 35	100	0023 1480	0023 1480A4	M-14 x 80	10
0023 0640	0023 0640A4	M-6 x 40	100	0023 1490	0023 1490A4	M-14 x 90	10
0023 0645	.	M-6 x 45	100	0023 16100	0023 16100A4	M-16 x 100	5
0023 0650	0023 0650A4	M-6 x 50	100	0023 1620	0023 1620A4	M-16 x 20	25
0023 0660	0023 0660A4	M-6 x 60	50	0023 1625	0023 1625A4	M-16 x 25	25
0023 0670	0023 0670A4	M-6 x 70	50	0023 1630	0023 1630A4	M-16 x 30	25
0023 0680	.	M-6 x 80	50	0023 1635	.	M-16 x 35	25
0023 0690	.	M-6 x 90	50	0023 1640	0023 1640A4	M-16 x 40	10
0023 0810	0023 0810A4	M-8 x 10	100	0023 1645	.	M-16 x 45	10
0023 08100	.	M-8 x 100	50	0023 1650	0023 1650A4	M-16 x 50	10
0023 08110	.	M-8 x 110	25	0023 1660	0023 1660A4	M-16 x 60	10
0023 0812	.	M-8 x 12	100	0023 1670	0023 1670A4	M-16 x 70	10
0023 0816	0023 0816A4	M-8 x 16	100	0023 1680	0023 1680A4	M-16 x 80	10
0023 0820	0023 0820A4	M-8 x 20	100	0023 1690	0023 1690A4	M-16 x 90	10



TORNILLO DE CABEZA AVELLANADA CON HUECO HEXAGONAL / VIS À MÉTAUX TÊTE FRAISÉE SIX PANS CREUX
HEXAGON SOCKET COUNTERSUNK HEAD SCREW / VITI A TESTA SVASATA PIANA CON ESAGONO INCASSATO
PARAFUSO DE CABEÇA ESCAREADA COM CAVIDADE HEXAGONAL

DIN 7991



INOX A2	INOX A4	M		INOX A2	INOX A4	M	
7991 0306I	.	M-3 x 06	200	7991 0660I	7991 0660A4	M-6 x 60	100
7991 0308I	.	M-3 x 08	200	7991 0670I	7991 0670A4	M-6 x 70	100
7991 0310I	7991 0310A4	M-3 x 10	200	7991 0680I	7991 0680A4	M-6 x 80	100
7991 0312I	7991 0312A4	M-3 x 12	200	7991 08100I	.	M-8 x 100	50
7991 0316I	7991 0316A4	M-3 x 16	200	7991 0810I	7991 0810A4	M-8 x 10	100
7991 0320I	7991 0320A4	M-3 x 20	200	7991 0812I	7991 0812A4	M-8 x 12	100
7991 0325I	7991 0325A4	M-3 x 25	200	7991 0816I	7991 0816A4	M-8 x 16	100
7991 0330I	7991 0330A4	M-3 x 30	200	7991 0820I	7991 0820A4	M-8 x 20	100
7991 0408I	.	M-4 x 8	200	7991 0825I	7991 0825A4	M-8 x 25	100
7991 0410I	7991 0410A4	M-4 x 10	200	7991 0830I	7991 0830A4	M-8 x 30	100
7991 0412I	7991 0412A4	M-4 x 12	200	7991 0835I	7991 0835A4	M-8 x 35	50
7991 0416I	7991 0416A4	M-4 x 16	200	7991 0840I	7991 0840A4	M-8 x 40	50
7991 0420I	7991 0420A4	M-4 x 20	200	7991 0845I	7991 0845A4	M-8 x 45	50
7991 0425I	7991 0425A4	M-4 x 25	200	7991 0850I	7991 0850A4	M-8 x 50	50
7991 0430I	7991 0430A4	M-4 x 30	200	7991 0860I	7991 0860A4	M-8 x 60	50
7991 0440I	7991 0440A4	M-4 x 40	200	7991 0870I	.	M-8 x 70	50
7991 0450I	7991 0450A4	M-4 x 50	200	7991 0880I	.	M-8 x 80	50
7991 0508I	.	M-5 x 8	200	7991 0890I	.	M-8 x 90	50
7991 0510I	7991 0510A4	M-5 x 10	200	7991 10100I	.	M-10 x 100	25
7991 0512I	7991 0512A4	M-5 x 12	200	7991 1016I	.	M-10 x 16	100
7991 0516I	7991 0516A4	M-5 x 16	200	7991 1020I	7991 1020A4	M-10 x 20	100
7991 0520I	7991 0520A4	M-5 x 20	200	7991 1025I	7991 1025A4	M-10 x 25	100
7991 0525I	7991 0525A4	M-5 x 25	200	7991 1030I	7991 1030A4	M-10 x 30	100
7991 0530I	7991 0530A4	M-5 x 30	200	7991 1035I	7991 1035A4	M-10 x 35	50
7991 0535I	7991 0535A4	M-5 x 35	100	7991 1040I	7991 1040A4	M-10 x 40	50
7991 0540I	7991 0540A4	M-5 x 40	100	7991 1050I	7991 1050A4	M-10 x 50	50
7991 0545I	7991 0545A4	M-5 x 45	100	7991 1060I	7991 1060A4	M-10 x 60	50
7991 0550I	7991 0550A4	M-5 x 50	100	7991 1080I	.	M-10 x 80	25
7991 0560I	7991 0560A4	M-5 x 60	100	7991 1090I	.	M-10 x 90	25
7991 0608I	.	M-6 x 8	200	7991 12100I	7991 12100A4	M-12 x 100	10
7991 0610I	7991 0610A4	M-6 x 10	200	7991 1230I	7991 1230A4	M-12 x 30	50
7991 0612I	7991 0612A4	M-6 x 12	200	7991 1235I	7991 1235A4	M-12 x 35	25
7991 0616I	7991 0616A4	M-6 x 16	200	7991 1240I	7991 1240A4	M-12 x 40	25
7991 0620I	7991 0620A4	M-6 x 20	200	7991 1245I	7991 1245A4	M-12 x 45	25
7991 0625I	7991 0625A4	M-6 x 25	200	7991 1250I	7991 1250A4	M-12 x 50	25
7991 0630I	7991 0630A4	M-6 x 30	200	7991 1260I	7991 1260A4	M-12 x 60	25
7991 0635I	7991 0635A4	M-6 x 35	100	7991 1270I	7991 1270A4	M-12 x 70	25
7991 0640I	7991 0640A4	M-6 x 40	100	7991 1280I	.	M-12 x 80	25
7991 0650I	7991 0650A4	M-6 x 50	100	7991 1290I	.	M-12 x 90	25



TORNILLO CABEZA CILÍNDRICA ABOMBADA MORTAJA ALLEN / VIS TÊTE CYLINDRIQUE BOMBÉE MORTAISE ALLEN
ALLEN PAN HEAD MACHINE SCREW PLATED / VITI A TESTA CILINDRICA BOMBATA ALLEN
PARAFUSO CABEÇA CILINDRICA CONVEXA ENCAIXE ALLEN

DIN 7380



INOX A2	INOX A4	M		INOX A2	INOX A4	M	
7380 0410I	7380 0410A4	M-4 x 10	200	7380 0630I	7380 0630A4	M-6 x 30	50
7380 0412I	7380 0412A4	M-4 x 12	200	7380 0635I	7380 0635A4	M-6 x 35	50
7380 0416I	7380 0416A4	M-4 x 16	200	7380 0640I	7380 0640A4	M-6 x 40	50
7380 0420I	7380 0420A4	M-4 x 10	200	7380 0645I	7380 0645A4	M-6 x 45	50
7380 0425I	7380 0425A4	M-4 x 25	100	7380 0650I	7380 0650A4	M-6 x 50	50
7380 0430I	7380 0430A4	M-4 x 30	100	7380 0660I	7380 0660A4	M-6 x 60	50
7380 0435I	7380 0435A4	M-4 x 35	100	7380 0816I	7380 0816A4	M-8 x 16	100
7380 0440I	7380 0440A4	M-4 x 40	100	7380 0820I	7380 0820A4	M-8 x 20	100
7380 0510I	7380 0510A4	M-5 x 10	200	7380 0825I	7380 0825A4	M-8 x 25	50
7380 0512I	7380 0512A4	M-5 x 12	200	7380 0830I	7380 0830A4	M-8 x 30	50
7380 0516I	7380 0516A4	M-5 x 16	200	7380 0840I	7380 0840A4	M-8 x 40	50
7380 0520I	7380 0520A4	M-5 x 20	200	7380 0845I	7380 0845A4	M-8 x 45	50
7380 0525I	7380 0525A4	M-5 x 25	100	7380 0850I	7380 0850A4	M-8 x 50	50
7380 0530I	7380 0530A4	M-5 x 30	100	7380 0860I	7380 0860A4	M-8 x 60	50
7380 0535I	7380 0535A4	M-5 x 35	100	7380 1020I	7380 1020A4	M-10 x 20	50
7380 0540I	7380 0540A4	M-5 x 40	100	7380 1025I	7380 1025A4	M-10 x 25	25
7380 0550I	7380 0550A4	M-5 x 50	100	7380 1030I	7380 1030A4	M-10 x 30	25
7380 0610I	7380 0610A4	M-6 x 10	100	7380 1035I	7380 1035A4	M-10 x 35	25
7380 0612I	7380 0612A4	M-6 x 12	100	7380 1040I	7380 1040A4	M-10 x 40	25
7380 0616I	7380 0616A4	M-6 x 16	100	7380 1045I	7380 1045A4	M-10 x 45	25
7380 0620I	7380 0620A4	M-6 x 20	100	7380 1050I	7380 1050A4	M-10 x 50	25
7380 0625I	7380 0625A4	M-6 x 25	50	7380 1060I	7380 1060A4	M-10 x 60	25

TORNILLO DIN 603 / VIS DIN 603 / SCREW DIN 603 / VITI DIN 603 / PARAFUSO DIN 603

DIN 603



INOX A2	INOX A4	M		INOX A2	INOX A4	M	
0087 06100I	.	M-6 x 100	100	0087 08150I	.	M-8 x 150	50
0087 0620I	0087 0620A4	M-6 x 20	200	0087 0820I	0087 0820A4	M-8 x 20	200
0087 0625I	.	M-6 x 25	200	0087 0825I	.	M-8 x 25	200
0087 0630I	0087 0630A4	M-6 x 30	200	0087 0830I	0087 0830A4	M-8 x 30	200
0087 0640I	0087 0640A4	M-6 x 40	200	0087 0840I	0087 0840A4	M-8 x 40	200
0087 0650I	0087 0650A4	M-6 x 50	200	0087 0850I	0087 0850A4	M-8 x 50	200
0087 0660I	0087 0660A4	M-6 x 60	100	0087 0860I	0087 0860A4	M-8 x 60	100
0087 0670I	0087 0670A4	M-6 x 70	100	0087 0870I	0087 0870A4	M-8 x 70	100
0087 0680I	0087 0680A4	M-6 x 80	100	0087 0880I	0087 0880A4	M-8 x 80	100
0087 0690I	.	M-6 x 90	100	0087 0890I	0087 0890A4	M-8 x 90	100
0087 08100I	0087 08100A4	M-8 x 100	100	0087 1030I	0087 1030A4	M-10 x 30	100
0087 08110I	.	M-8 x 110	50	0087 1040I	0087 1040A4	M-10 x 40	100
0087 08120I	0087 08120A4	M-8 x 120	50	0087 1050I	0087 1050A4	M-10 x 50	100
0087 08130I	.	M-8 x 130	50	0087 1060I	0087 1060A4	M-10 x 60	50
0087 08140I	.	M-8 x 140	50				



TUERCA HEXAGONAL / ECROUS HEXAGONAUX / HEXAGONAL NUT / DADI ESAGONALI / PORCA HEXAGONAL



DIN 934

INOX A2	INOX A4	M	
0028 0003	0028 0003A4	M-3	500
0028 0004	0028 0004A4	M-4	500
0028 0005	0028 0005A4	M-5	500
0028 0006	0028 0006A4	M-6	500
0028 0008	0028 0008A4	M-8	250
0028 0010	0028 0010A4	M-10	200
0028 0012	0028 0012A4	M-12	100
0028 0014	0028 0014A4	M-14	100

INOX A2	INOX A4	M	
0028 0016	0028 0016A4	M-16	50
0028 0018	0028 0018A4	M-18	50
0028 0020	0028 0020A4	M-20	25
0028 0022	0028 0022A4	M-22	25
0028 0024	0028 0024A4	M-24	10
0028 0027	0028 0027A4	M-27	5
0028 0030	0028 0030A4	M-30	5



TUERCAS HEXAGONALES DE SEGURIDAD CON ARANDELA NYLON / ECROUS HEXAGONAUX INDESSERABLES AVEC BAGUE NYLON
HEXAGON LOCKNUT WITH NYLON INSERT / DADI ESAGONALI DI SICUREZZA CON RONDELLE IN NYLON
PORCA HEXAGONAL DE SEGURANÇA COM ARRUELA NYLON



DIN 985

INOX A2	INOX A4	M	
0029 0003	0029 0003A4	M-3	500
0029 0004	0029 0004A4	M-4	500
0029 0005	0029 0005A4	M-5	500
0029 0006	0029 0006A4	M-6	500
0029 0008	0029 0008A4	M-8	250
0029 0010	0029 0010A4	M-10	200
0029 0012	0029 0012A4	M-12	100
0029 0014	0029 0014A4	M-14	50

INOX A2	INOX A4	M	
0029 0016	0029 0016A4	M-16	25
0029 0018	0029 0018A4	M-18	25
0029 0020	0029 0020A4	M-20	25
0029 0022	0029 0022A4	M-22	10
0029 0024	0029 0024A4	M-24	10
0029 0027	0029 0027A4	M-27	5
0029 0030	0029 0030A4	M-30	5



TUERCA DE MARIPOSA / ECROUS A OREILLES FORME AMERICAINE / WING NUT AMERICAN TYPE / DADI CON ALETTE / PORCAS DE BORBOLETA



DIN 315

INOX A2	INOX A4	M	
0043 0003	0043 0003A4	M-3	200
0043 0004	0043 0004A4	M-4	200
0043 0005	0043 0005A4	M-5	200
0043 0006	0043 0006A4	M-6	100
0043 0008	0043 0008A4	M-8	100
0043 0010	0043 0010A4	M-10	50
0043 0012	0043 0012A4	M-12	25
0043 0014	0043 0014A4	M-14	10
0043 0016	0043 0016A4	M-16	10



TUERCAS CIEGAS / ECROUS BORGNE / HEXAGON CAP NUT / DADI ESAGONALI CIECHI / PORCAS DE MAMA



DIN 1587

INOX A2	INOX A4	M	
0044 0003	0044 0003A4	M-3	200
0044 0004	0044 0004A4	M-4	200
0044 0005	0044 0005A4	M-5	200
0044 0006	0044 0006A4	M-6	100
0044 0008	0044 0008A4	M-8	100
0044 0010	0044 0010A4	M-10	50
0044 0012	0044 0012A4	M-12	50
0044 0014	0044 0014A4	M-14	25
0044 0016	0044 0016A4	M-16	10
0044 0018	0044 0018A4	M-18	10
0044 0020	0044 0020A4	M-20	5



ARANDELA PLANA ALA ANCHA / RONDELLES PLATES / PLAIN WASHER / RONDELLE PIATTE / ARRUELA LISA COM ABA LARGA

DIN 9021

INOX
A2 / A4

INOX A2	INOX A4	M	
0030 0003	0030 0003A4	M-3	500
0030 0004	0030 0004A4	M-4	500
0030 0005	0030 0005A4	M-5	500
0030 0006	0030 0006A4	M-6	500
0030 0008	0030 0008A4	M-8	250
0030 0010	0030 0010A4	M-10	100
0030 0012	0030 0012A4	M-12	100
0030 0014	0030 0014A4	M-14	50
0030 0016	0030 0016A4	M-16	50
0030 0018	0030 0018A4	M-18	25
0030 0020	0030 0020A4	M-20	25
0030 0022	0030 0022A4	M-22	20
0030 0024	0030 0024A4	M-24	20

ARANDELAS PLANAS / RONDELLES PLATES DÉCOUPÉES / PLAIN STAMPED WASHER / RONDELLE PIATTE / ARRUELA LISA

DIN 125

INOX
A2 / A4

INOX A2	INOX A4	M	
0027 0003	0027 0003A4	M-3	500
0027 0004	0027 0004A4	M-4	500
0027 0005	0027 0005A4	M-5	500
0027 0006	0027 0006A4	M-6	500
0027 0008	0027 0008A4	M-8	250
0027 0010	0027 0010A4	M-10	200
0027 0012	0027 0012A4	M-12	100
0027 0014	0027 0014A4	M-14	100
0027 0016	0027 0016A4	M-16	100
0027 0018	0027 0018A4	M-18	100
0027 0020	0027 0020A4	M-20	50
0027 0022	0027 0022A4	M-22	50
0027 0024	0027 0024A4	M-24	25
0027 0027	0027 0027A4	M-27	10
0027 0030	0027 0030A4	M-30	5

ARANDELAS GROWER / RONDELLES ELASTIQUES "GROWER" / SPRING LOCK WASHER / RONDELLE GROWER / ARRUELA GROWER

DIN 127

INOX
A2 / A4

INOX A2	INOX A4	M	
0031 0003	0031 0003A4	M-3	500
0031 0004	0031 0004A4	M-4	500
0031 0005	0031 0005A4	M-5	500
0031 0006	0031 0006A4	M-6	500
0031 0008	0031 0008A4	M-8	250
0031 0010	0031 0010A4	M-10	200
0031 0012	0031 0012A4	M-12	200
0031 0014	0031 0014A4	M-14	100
0031 0016	0031 0016A4	M-16	100
0031 0018	0031 0018A4	M-18	50
0031 0020	0031 0020A4	M-20	25
0031 0022	0031 0022A4	M-22	10
0031 0024	0031 0024A4	M-24	10
0031 0027	0031 0027A4	M-27	5
0031 0030	0031 0030A4	M-30	5



ALCAYATAS Y HEMBRILLAS ZINCADAS / CROCHET DE FIXATION / HOOK OF FIXATION
GANCI A RAMPINO / ESCÁPULAS E GANCHOS ZINCADOS



ALCAYATA ROSCA / HOOK OF FIXATION

Ref. 0106
+ Medida / Dimensions / Size / Dimensioni / Medida + I

INOX A2	B	L	H	
0106 3030I	3,0	30	10	50
0106 3540I	3,5	40	10	50
0106 4045I	4,0	45	15	50
0106 5060I	5,0	60	20	50

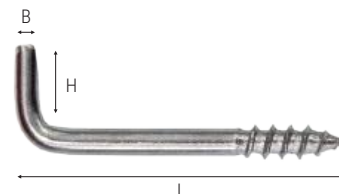

HEMRILLA ABIERTA / OPEN HOOK

Ref. 0108
+ Medida / Dimensions / Size / Dimensioni / Medida + I

INOX A2	B	L	H	
0108 3340I	3,3	40	14	50
0108 3550I	3,5	50	17	50
0108 3560I	3,5	60	16	50
0108 4450I	4,4	50	16	50
0108 4465I	4,4	65	22	50
0108 5280I	5,2	80	26	50
0108 60100I	6,0	100	26	50

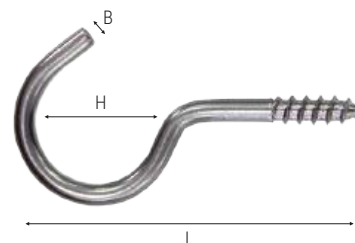

HEMRILLA CERRADA / CLOSED HOOK

Ref. 0107
+ Medida / Dimensions / Size / Dimensioni / Medida + I

INOX A2	B	L	H	
0107 3316I	3,3	16	8	50
0107 3720I	3,7	20	10	50
0107 4025I	4,0	25	12	50
0107 4430I	4,4	30	14	50

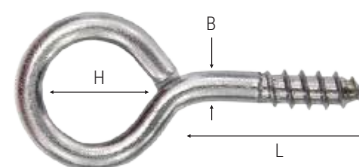

VARILLA ROSCADA 1 METRO / TIGES FILETÉES - LONGUEUR 1 METRE / THREADED ROD - 1 METER LONG
VITI SENZA TESTA - 1 METRO DI LUNGHEZZA / HASTE ROSCADA 1 METRO



DIN 975

1 m

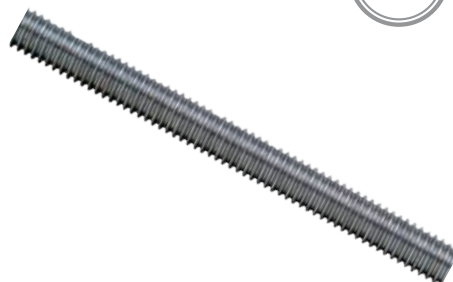

INOX A2	INOX A4	M	
0042 0003	0042 0003A4	M-3	1
0042 0004	0042 0004A4	M-4	1
0042 0005	0042 0005A4	M-5	1
0042 0006	0042 0006A4	M-6	1
0042 0008	0042 0008A4	M-8	1
0042 0010	0042 0010A4	M-10	1
0042 0012	0042 0012A4	M-12	1
0042 0014	0042 0014A4	M-14	1

INOX A2	INOX A4	M	
0042 0016	0042 0016A4	M-16	1
0042 0018	0042 0018A4	M-18	1
0042 0020	0042 0020A4	M-20	1
0042 0022	0042 0022A4	M-22	1
0042 0024	0042 0024A4	M-24	1
0042 0027	.	M-27	1
0042 0030	.	M-30	1

TORNILLOS CABEZA CILÍNDRICA RANURADA / VIS A METAUX TÊTE CYLINDRIQUE FENDUE / SLOTTED CHEESE HEAD MACHINE SCREW
VITI IN FERRO PER METALLO TAGLIO A CACCIAVITE / PARAFUSOS CABEÇA CILÍNDRICA RANHURADA

DIN 84



INOX A2	INOX A4	M	
0060 0310I	0060 0310A4	M-3 x 10	200
0060 0312I	0060 0312A4	M-3 x 12	200
0060 0316I	0060 0316A4	M-3 x 16	200
0060 0410I	0060 0410A4	M-4 x 10	200
0060 0416I	0060 0416A4	M-4 x 16	200
0060 0420I	0060 0420A4	M-4 x 20	200
0060 0430I	0060 0430A4	M-4 x 30	200
0060 0440I	0060 0440A4	M-4 x 40	200
0060 0450I	0060 0450A4	M-4 x 50	200
0060 0516I	0060 0516A4	M-5 x 16	200
0060 0520I	0060 0520A4	M-5 x 20	200
0060 0530I	0060 0530A4	M-5 x 30	100
0060 0540I	0060 0540A4	M-5 x 40	100

INOX A2	INOX A4	M	
0060 0550I	0060 0550A4	M-5 x 50	50
0060 0616I	0060 0616A4	M-6 x 16	200
0060 0620I	0060 0620A4	M-6 x 20	200
0060 0630I	0060 0630A4	M-6 x 30	100
0060 0640I	0060 0640A4	M-6 x 40	100
0060 0650I	0060 0650A4	M-6 x 50	100
0060 0660I	0060 0660A4	M-6 x 60	50
0060 0820I	.	M-8 x 20	100
0060 0830I	0060 0830A4	M-8 x 30	100
0060 0840I	0060 0840A4	M-8 x 40	100
0060 0850I	0060 0850A4	M-8 x 50	50
0060 0860I	0060 0860A4	M-8 x 60	50

TORNILLO CABEZA CILÍNDRICA ABOMBADA POZIDRIVE / VIS À MÉTAUX TÊTE CYLINDRIQUE EMPREINTE POZIDRIVE
POZIDRIVE CROSS RECESSED PAN HEAD MACHINE SCREW / VITI IN FERRO PER METALLO TAGLIO A CROCE
PARAFUSO CABEÇA CILÍNDRICA ABAULADA POZIDRIVE

DIN 7985



INOX A2	INOX A4	M	
0064 0306I	0064 0306A4	M-3 x 6	100
0064 0308I	0064 0308A4	M-3 x 8	100
0064 0310I	0064 0310A4	M-3 x 10	100
0064 0316I	0064 0316A4	M-3 x 16	100
0064 0320I	0064 0320A4	M-3 x 20	100
0064 0325I	.	M-3 x 25	100
0064 0330I	0064 0330A4	M-3 x 30	100
0064 0406I	0064 0406A4	M-4 x 6	100
0064 0408I	0064 0408A4	M-4 x 8	100
0064 0410I	0064 0410A4	M-4 x 10	100
0064 0412I	.	M-4 x 12	100
0064 0416I	0064 0416A4	M-4 x 16	100
0064 0420I	0064 0420A4	M-4 x 20	100
0064 0425I	.	M-4 x 25	100
0064 0430I	0064 0430A4	M-4 x 30	100
0064 0435I	.	M-4 x 35	100
0064 0440I	0064 0440A4	M-4 x 40	100
0064 0450I	.	M-4 x 50	50
0064 0460I	.	M-4 x 60	50
0064 0508I	.	M-5 x 8	100
0064 0510I	0064 0510A4	M-5 x 10	100
0064 0516I	0064 0516A4	M-5 x 16	100

INOX A2	INOX A4	M	
0064 0520I	0064 0520A4	M-5 x 20	100
0064 0525I	.	M-5 x 25	100
0064 0530I	0064 0530A4	M-5 x 30	100
0064 0535I	.	M-5 x 35	100
0064 0540I	0064 0540A4	M-5 x 40	100
0064 0550I	0064 0550A4	M-5 x 50	50
0064 0560I	.	M-5 x 60	50
0064 0570I	.	M-5 x 70	50
0064 0580I	.	M-5 x 80	50
0064 0610I	0064 0610A4	M-6 x 10	100
0064 0612I	.	M-6 x 12	100
0064 0616I	0064 0616A4	M-6 x 16	100
0064 0620I	0064 0620A4	M-6 x 20	100
0064 0625I	.	M-6 x 25	100
0064 0630I	0064 0630A4	M-6 x 30	100
0064 0635I	.	M-6 x 35	100
0064 0640I	0064 0640A4	M-6 x 40	100
0064 0650I	0064 0650A4	M-6 x 50	50
0064 0660I	0064 0660A4	M-6 x 60	50
0064 0670I	.	M-6 x 70	50
0064 0680I	.	M-6 x 80	50



TORNILLOS CABEZA AVELLANADA RANURADA / VIS À MÉTAUX TÊTE FRAISÉE FENDUE / SLOTTED COUNTERSUNK HEAD MACHINE SCREW
VITI CON TESTA SVASATA / PARAFUSOS CABEÇA ESCAREADA RANHURADA

DIN 963

**INOX
A2 / A4**



INOX A2	INOX A4	M	
0061 0310I	0061 0310A4	M-3 x 10	100
0061 0316I	0061 0316A4	M-3 x 16	100
0061 0330I	0061 0330A4	M-3 x 30	100
0061 0408I	.	M-4 x 8	100
0061 0410I	0061 0410A4	M-4 x 10	100
0061 0412I	0061 0412A4	M-4 x 12	100
0061 0416I	0061 0416A4	M-4 x 16	100
0061 0420I	0061 0420A4	M-4 x 20	100
0061 0425I	.	M-4 x 25	100
0061 0430I	0061 0430A4	M-4 x 30	100
0061 0440I	0061 0440A4	M-4 x 40	100
0061 0450I	.	M-4 x 50	100
0061 0510I	0061 0510A4	M-5 x 10	100
0061 0516I	0061 0516A4	M-5 x 16	100
0061 0520I	0061 0520A4	M-5 x 20	100
0061 0525I	.	M-5 x 25	100
0061 0530I	0061 0530A4	M-5 x 30	100
0061 0540I	0061 0540A4	M-5 x 40	100
0061 0550I	0061 0550A4	M-5 x 50	50
0061 0560I	0061 0560A4	M-5 x 60	50
0061 06100I	.	M-6 x 100	50

INOX A2	INOX A4	M	
0061 0616I	0061 0616A4	M-6 x 16	100
0061 0620I	0061 0620A4	M-6 x 20	100
0061 0625I	.	M-6 x 25	100
0061 0630I	0061 0630A4	M-6 x 30	100
0061 0640I	0061 0640A4	M-6 x 40	100
0061 0650I	0061 0650A4	M-6 x 50	50
0061 0660I	0061 0660A4	M-6 x 60	50
0061 0670I	.	M-6 x 70	50
0061 0680I	.	M-6 x 80	50
0061 0690I	.	M-6 x 90	50
0061 0830I	0061 0830A4	M-8 x 30	100
0061 0840I	0061 0840A4	M-8 x 40	100
0061 0850I	0061 0850A4	M-8 x 50	50
0061 0860I	0061 0860A4	M-8 x 60	50
0061 0870I	0061 0870A4	M-8 x 70	50
0061 0880I	0061 0880A4	M-8 x 80	50
0061 1040I	0061 1040A4	M-10 x 40	50
0061 1050I	0061 1050A4	M-10 x 50	25
0061 1060I	0061 1060A4	M-10 x 60	25
0061 1070I	0061 1070A4	M-10 x 70	10
0061 1080I	0061 1080A4	M-10 x 80	10

TORNILLOS CABEZA AVELLANADA RANURADA / VIS À MÉTAUX TÊTE FRAISÉE FENDUE / SLOTTED COUNTERSUNK HEAD MACHINE SCREW
VITI CON TESTA SVASATA / PARAFUSOS CABEÇA ESCAREADA RANHURADA

DIN 965

**INOX
A2 / A4**





INOX A2	INOX A4	M	
0065 0308I	0065 0308A4	M-3 x 8	100
0065 0310I	0065 0310A4	M-3 x 10	100
0065 0316I	0065 0316A4	M-3 x 16	100
0065 0320I	0065 0320A4	M-3 x 20	100
0065 0330I	.	M-3 x 30	100
0065 0340I	.	M-3 x 40	100
0065 0408I	0065 0408A4	M-4 x 8	100
0065 0410I	0065 0410A4	M-4 x 10	100
0065 0412I	.	M-4 x 12	100
0065 0416I	0065 0416A4	M-4 x 16	100
0065 0420I	0065 0420A4	M-4 x 20	100
0065 0425I	.	M-4 x 25	100
0065 0430I	0065 0430A4	M-4 x 30	100
0065 0440I	0065 0440A4	M-4 x 40	100
0065 0510I	0065 0510A4	M-5 x 10	100
0065 0516I	.	M-5 x 16	100
0065 0520I	0065 0520A4	M-5 x 20	100
0065 0525I	.	M-5 x 25	100
0065 0530I	0065 0530A4	M-5 x 30	100

INOX A2	INOX A4	M	
0065 0540I	0065 0540A4	M-5 x 40	100
0065 0550I	0065 0550A4	M-5 x 50	100
0065 0560I	0065 0560A4	M-5 x 60	100
0065 0610I	.	M-6 x 10	100
0065 0612I	.	M-6 x 12	100
0065 0616I	0065 0616A4	M-6 x 16	100
0065 0620I	0065 0620A4	M-6 x 20	100
0065 0625I	.	M-6 x 25	100
0065 0630I	0065 0630A4	M-6 x 30	100
0065 0640I	0065 0640A4	M-6 x 40	100
0065 0650I	0065 0650A4	M-6 x 50	50
0065 0660I	0065 0660A4	M-6 x 60	50
0065 0670I	.	M-6 x 70	50
0065 0680I	.	M-6 x 80	50
0065 0820I	.	M-8 x 20	100
0065 0825I	.	M-8 x 25	100
0065 0830I	.	M-8 x 30	100
0065 0840I	.	M-8 x 40	100

TORNILLO ROSCACHAPA CABEZA CILÍNDRICA ABOMBADA PHILLIPS / VIS À TÔLE TÊTE CYLINDRIQUE LARGE IMPREINTE PHILLIPS
PHILLIPS CROSS RECESSED PAN HEAD SELF TAPPING SCREW / VITI AUTOFILETTANTI CON TESTA CILINDRICA BOMBATA PHILLIPS
PARAFUSOS AUTORROSCANTES CABEÇA CILÍNDRICA ABAULADA PHILLIPS

DIN 7981





INOX A2	INOX A4	M		INOX A2	INOX A4	M	
0111 2913I	0111 2913A4	M-2,9 x 13	200	0111 4813I	0111 4813A4	M-4,8 x 13	100
0111 2916I	0111 2916A4	M-2,9 x 16	200	0111 4816I	0111 4816A4	M-4,8 x 16	100
0111 2919I	0111 2919A4	M-2,9 x 19	200	0111 4819I	0111 4819A4	M-4,8 x 19	100
0111 2965I		M-2,9 x 65	200	0111 4822I	0111 4822A4	M-4,8 x 22	100
0111 2995I		M-2,9 x 9,5	200	0111 4825I	0111 4825A4	M-4,8 x 25	100
0111 3513I	0111 3513A4	M-3,5 x 13	200	0111 4832I	0111 4832A4	M-4,8 x 32	100
0111 3516I	0111 3516A4	M-3,5 x 16	200	0111 4838I	0111 4838A4	M-4,8 x 38	100
0111 3519I	0111 3519A4	M-3,5 x 19	200	0111 4845I	0111 4845A4	M-4,8 x 45	100
0111 3522I		M-3,5 x 22	200	0111 4850I	0111 4850A4	M-4,8 x 50	100
0111 3525I	0111 3525A4	M-3,5 x 25	200	0111 4860I	0111 4860A4	M-4,8 x 60	100
0111 3532I	0111 3532A4	M-3,5 x 32	200	0111 4870I		M-4,8 x 70	100
0111 3538I	0111 3538A4	M-3,5 x 38	200	0111 5513I	0111 5513A4	M-5,5 x 13	100
0111 3595I		M-3,5 x 9,5	200	0111 5516I	0111 5516A4	M-5,5 x 16	100
0111 3913I	0111 3913A4	M-3,9 x 13	200	0111 5519I	0111 5519A4	M-5,5 x 19	100
0111 3916I	0111 3916A4	M-3,9 x 16	200	0111 5522I		M-5,5 x 22	100
0111 3919I	0111 3919A4	M-3,9 x 19	200	0111 5525I	0111 5525A4	M-5,5 x 25	100
0111 3922I		M-3,9 x 22	200	0111 5532I	0111 5532A4	M-5,5 x 32	100
0111 3925I	0111 3925A4	M-3,9 x 25	200	0111 5538I	0111 5538A4	M-5,5 x 38	100
0111 3932I	0111 3932A4	M-3,9 x 32	200	0111 5545I	0111 5545A4	M-5,5 x 45	100
0111 3938I	0111 3938A4	M-3,9 x 38	200	0111 5550I	0111 5550A4	M-5,5 x 50	100
0111 3950I		M-3,9 x 50	100	0111 5560I	0111 5560A4	M-5,5 x 60	100
0111 3995I		M-3,9 x 9,5	200	0111 5570I		M-5,5 x 70	100
0111 4213I	0111 4213A4	M-4,2 x 13	200	0111 5580I		M-5,5 x 80	50
0111 4216I	0111 4216A4	M-4,2 x 16	200	0111 6316I	0111 6316A4	M-6,3 x 16	50
0111 4219I	0111 4219A4	M-4,2 x 19	200	0111 6319I	0111 6319A4	M-6,3 x 19	50
0111 4222I		M-4,2 x 22	200	0111 6325I	0111 6325A4	M-6,3 x 25	50
0111 4225I	0111 4225A4	M-4,2 x 25	200	0111 6332I	0111 6332A4	M-6,3 x 32	50
0111 4232I	0111 4232A4	M-4,2 x 32	200	0111 6338I	0111 6338A4	M-6,3 x 38	50
0111 4238I	0111 4238A4	M-4,2 x 38	200	0111 6345I	0111 6345A4	M-6,3 x 45	50
0111 4245I	0111 4245A4	M-4,2 x 45	200	0111 6350I	0111 6350A4	M-6,3 x 50	50
0111 4250I	0111 4250A4	M-4,2 x 50	100	0111 6360I	0111 6360A4	M-6,3 x 60	50
0111 4260I		M-4,2 x 60	100	0111 6370I		M-6,3 x 70	50

TORNILLO ROSCACHAPA CABEZA AVELLANADA PHILLIPS / VIS À TÔLE TÊTE FRAISÉE EMPREINTE PHILLIPS
PHILLIPS CROSS RECESSED COUNTERSUNK HEAD SELF TAPPING SCREW / VITI AUTOFILETTANTI CON TESTA SVASATA PHILLIPS
PARAFUSOS AUTORROSCANTES CABEÇAS ESCAREADAS PHILLIPS

DIN 7982



INOX A2	INOX A4	M		INOX A2	INOX A4	M	
0113 2913I	0113 2913A4	M-2,9 x 13	200	0113 4238I	0113 4238A4	M-4,2 x 38	200
0113 2916I	0113 2916A4	M-2,9 x 16	200	0113 4245I	0113 4245A4	M-4,2 x 45	200
0113 2919I	0113 2919A4	M-2,9 x 19	200	0113 4250I	0113 4250A4	M-4,2 x 50	100
0113 2925I	0113 2925A4	M-2,9 x 25	200	0113 4813I	0113 4813A4	M-4,8 x 13	100
0113 2932I		M-2,9 x 32	200	0113 4816I	0113 4816A4	M-4,8 x 16	100
0113 2995I		M-2,9 x 95	200	0113 4819I	0113 4819A4	M-4,8 x 19	100
0113 3513I	0113 3513A4	M-3,5 x 13	200	0113 4825I	0113 4825A4	M-4,8 x 25	100
0113 3516I	0113 3516A4	M-3,5 x 16	200	0113 4832I	0113 4832A4	M-4,8 x 32	100
0113 3519I	0113 3519A4	M-3,5 x 19	200	0113 4838I	0113 4838A4	M-4,8 x 38	100
0113 3525I	0113 3525A4	M-3,5 x 25	200	0113 4845I	0113 4845A4	M-4,8 x 45	100
0113 3532I	0113 3532A4	M-3,5 x 32	200	0113 4850I	0113 4850A4	M-4,8 x 50	100
0113 3538I	0113 3538A4	M-3,5 x 38	200	0113 5519I	0113 5519A4	M-5,5 x 19	100
0113 3595I		M-3,5 x 95	200	0113 5525I	0113 5525A4	M-5,5 x 25	100
0113 3916I	0113 3916A4	M-3,9 x 16	200	0113 5532I	0113 5532A4	M-5,5 x 32	100
0113 3919I	0113 3919A4	M-3,9 x 19	200	0113 5538I	0113 5538A4	M-5,5 x 38	100
0113 3925I	0113 3925A4	M-3,9 x 25	200	0113 5550I	0113 5550A4	M-5,5 x 50	100
0113 3932I	0113 3932A4	M-3,9 x 32	200	0113 5560I	0113 5560A4	M-5,5 x 60	100
0113 3938I	0113 3938A4	M-3,9 x 38	200	0113 6319I	0113 6319A4	M-6,3 x 19	50
0113 3995I		M-3,9 x 9,5	200	0113 6325I	0113 6325A4	M-6,3 x 25	50
0113 4213I	0113 4213A4	M-4,2 x 13	200	0113 6332I	0113 6332A4	M-6,3 x 32	50
0113 4216I	0113 4216A4	M-4,2 x 16	200	0113 6338I	0113 6338A4	M-6,3 x 38	50
0113 4219I	0113 4219A4	M-4,2 x 19	200	0113 6350I	0113 6350A4	M-6,3 x 50	50
0113 4225I	0113 4225A4	M-4,2 x 25	200	0113 6360I	0113 6360A4	M-6,3 x 60	50
0113 4232I	0113 4232A4	M-4,2 x 32	200				



TORNILLOS PARA AGLOMERADO DE CABEZA AVELLANADA POZIDRIVE / VIS À BOIS TÊTE FRAISÉE EMPREINTE POZIDRIVE
POZIDRIVE CROSS RECESSED COUNTERSUNK HEAD CHIPBOARD SCREW / VITI PER LEGNO CON TESTA SVASATA POZIDRIVE
PARAFUSO AGLOMERADO CABEÇA ESCAREADA POZIDRIVE

DIN 7505A



INOX A2	INOX A4	M		INOX A2	INOX A4	M	
0250 0316I	0250 0316A4	M-3 x 16	200	0250 06100I	0250 06100A4	M-6 x 100	100
0250 0320I	0250 0320A4	M-3 x 20	200	0250 06120I	.	M-6 x 120	50
0250 0325I	0250 0325A4	M-3 x 25	200	0250 0645I	0250 0645A4	M-6 x 45	100
0250 0416I	0250 0416A4	M-4 x 16	200	0250 0650I	0250 0650A4	M-6 x 50	100
0250 0420I	0250 0420A4	M-4 x 20	200	0250 0660I	0250 0660A4	M-6 x 60	100
0250 0425I	0250 0425A4	M-4 x 25	200	0250 0670I	0250 0670A4	M-6 x 70	100
0250 0430I	0250 0430A4	M-4 x 30	200	0250 0680I	0250 0680A4	M-6 x 80	100
0250 0435I	0250 0435A4	M-4 x 35	200	0250 3516I	0250 3516A4	M-3,5 x 16	200
0250 0440I	0250 0440A4	M-4 x 40	200	0250 3520I	0250 3520A4	M-3,5 x 20	200
0250 0450I	0250 0450A4	M-4 x 50	200	0250 3525I	0250 3525A4	M-3,5 x 25	200
0250 0460I	0250 0460A4	M-4 x 60	200	0250 3530I	0250 3530A4	M-3,5 x 30	200
0250 0470I	.	M-4 x 70	100	0250 3535I	0250 3535A4	M-3,5 x 35	200
0250 05100I	.	M-5 x 100	100	0250 3540I	0250 3540A4	M-3,5 x 40	200
0250 0520I	0250 0520A4	M-5 x 20	200	0250 3550I	0250 3550A4	M-3,5 x 50	200
0250 0525I	0250 0525A4	M-5 x 25	200	0250 4525I	.	M-4,5 x 25	200
0250 0530I	0250 0530A4	M-5 x 30	200	0250 4530I	0250 4530A4	M-4,5 x 30	200
0250 0540I	0250 0540A4	M-5 x 40	200	0250 4535I	0250 4535A4	M-4,5 x 35	200
0250 0550I	0250 0550A4	M-5 x 50	200	0250 4540I	0250 4540A4	M-4,5 x 40	200
0250 0560I	0250 0560A4	M-5 x 60	200	0250 4545I	0250 4545A4	M-4,5 x 45	200
0250 0570I	0250 0570A4	M-5 x 70	100	0250 4550I	0250 4550A4	M-4,5 x 50	100
0250 0580I	0250 0580A4	M-5 x 80	100	0250 4560I	0250 4560A4	M-4,5 x 60	100
0250 0590I	.	M-5 x 90	100	0250 4580I	.	M-4,5 x 80	100

TIRAFONDOS / VIS À BOIS TÊTE HEXAGONALE / HEXAGON HEAD WOOD SCREW / TIRAFONDI / PARAFUSOS

DIN 571



INOX A2	INOX A4	M		INOX A2	INOX A4	M	
0126 0530I	0126 0530A4	M-5 x 30	200	0126 0840I	0126 0840A4	M-8 x 40	100
0126 0540I	0126 0540A4	M-5 x 40	100	0126 0850I	0126 0850A4	M-8 x 50	100
0126 0550I	0126 0550A4	M-5 x 50	100	0126 0860I	0126 0860A4	M-8 x 60	100
0126 0560I	0126 0560A4	M-5 x 60	100	0126 0870I	0126 0870A4	M-8 x 70	100
0126 06100I	.	M-6 x 100	50	0126 0880I	0126 0880A4	M-8 x 80	50
0126 0640I	0126 0640A4	M-6 x 40	100	0126 0890I	0126 0890A4	M-8 x 90	50
0126 0650I	0126 0650A4	M-6 x 50	100	0126 10100I	0126 10100A4	M-10 x 100	50
0126 0660I	0126 0660A4	M-6 x 60	100	0126 1040I	0126 1040A4	M-10 x 40	50
0126 0670I	0126 0670A4	M-6 x 70	100	0126 1050I	0126 1050A4	M-10 x 50	50
0126 0680I	0126 0680A4	M-6 x 80	50	0126 1060I	0126 1060A4	M-10 x 60	50
0126 0690I	0126 0690A4	M-6 x 90	50	0126 1070I	0126 1070A4	M-10 x 70	50
0126 0750I	.	M-7 x 50	100	0126 1080I	0126 1080A4	M-10 x 80	50
0126 0760I	.	M-7 x 60	100	0126 12100I	.	M-12 x 100	25
0126 0770I	.	M-7 x 70	100	0126 1260I	.	M-12 x 60	25
0126 0780I	.	M-7 x 80	50	0126 1270I	.	M-12 x 70	25
0126 08100I	0126 08100A4	M-8 x 100	50	0126 1280I	0126 1280A4	M-12 x 80	25
0126 08110I	.	M-8 x 110	50	0126 1290I	.	M-12 x 90	25



DIÁMETROS DE TALADRO / VISSERIE / FASTENER'S DIAMETERS / DIAMETRO FORI / DIÂMETROS DAS BROCAS

ROSCA MÉTRICA-ISO

Ø	X	P
M 2	x	40
M 2,5	x	45
M 3	x	50
M 4	x	70
M 5	x	80
M 6	x	75
M 6	x	100
M 7	x	75
M 7	x	100
M 8	x	100
M 8	x	125
M 9	x	100
M 9	x	125
M 10	x	100
M 10	x	125
M 10	x	150
M 11	x	150
M 12	x	125
M 12	x	150
M 12	x	175
M 14	x	150
M 14	x	200
M 16	x	150
M 16	x	200
M 18	x	150
M 18	x	250
M 20	x	150
M 20	x	250
M 22	x	150
M 22	x	250
M 24	x	150
M 24	x	200
M 24	x	300
M 27	x	300
M 30	x	350
M 33	x	150
M 33	x	350
M 36	x	150
M 36	x	300
M 36	x	400
M 39	x	300
M 39	x	400
M 42	x	300
M 42	x	450
M 45	x	300
M 45	x	450
M 48	x	500
M 52	x	500

THICKNESS CONVERSION FROM MILIMETERS TO ISO NUMBERS

mm	2,2	2,9	3,3	3,5	3,9	4,2	4,8	5,5	6,3
ISO	Nº 2	Nº 4	Nº 5	Nº 6	Nº 7	Nº 8	Nº 10	Nº 12	Nº 14

ROSCA WHITWORTH

Ø	P	Ø Nominal mm
1/8	- 40 h	3,17
5/32	- 32 h	3,97
3/16	- 24 h	4,76
7/32	- 24 h	5,55
1/4	- 20 h	6,35
5/16	- 18 h	7,94
3/8	- 16 h	9,52
7/16	- 14 h	11,11
1/2	- 12 h	12,70
9/16	- 12 h	14,28
5/8	- 11 h	15,87
3/4	- 10 h	19,05
7/8	- 9 h	22,22
1"	- 8 h	25,40
1 1/8	- 7 h	28,57
1 1/4	- 7 h	31,75
1 3/8	- 6 h	34,92
1 1/2	- 6 h	38,10
1 5/8	- 5 h	41,27
1 3/4	- 5 h	44,45
1 7/8	- 4 1/2 h	47,62
2"	- 4 1/2 h	50,80

ROSCA UNC

Ø	P	Ø Nominal mm
Nº 4	- 40 h	2,84
Nº 5	- 40 h	3,17
Nº 6	- 32 h	3,50
Nº 8	- 32 h	4,16
Nº 10	- 24 h	4,82
Nº 12	- 24 h	5,48
1/4	- 20 h	6,35
5/16	- 18 h	7,94
3/8	- 16 h	9,52
7/16	- 14 h	11,11
1/2	- 13 h	12,70
9/16	- 12 h	14,29
5/8	- 11 h	15,87
3/4	- 10 h	19,05
7/8	- 9 h	22,22
1"	- 8 h	25,40
1 1/8	- 7 h	28,57
1 1/4	- 7 h	31,75
1 1/2	- 6 h	38,10

ROSCA GAS

Ø	P	Ø Nominal mm
1/8	- 28 h	9,73
1/4	- 19 h	13,15
3/8	- 19 h	16,66
1/2	- 14 h	20,95
5/8	- 14 h	23,91
3/4	- 14 h	26,44
7/8	- 14 h	30,20
1"	- 11 h	33,25
1 1/8	- 11 h	37,89
1 1/4	- 11 h	41,91
1 3/8	- 11 h	44,32
1 1/2	- 11 h	47,80
1 5/8	- 11 h	51,32
1 3/4	- 11 h	53,75
2"	- 11 h	59,61
2 1/4	- 11 h	69,30
2 1/2	- 11 h	75,19

ROSCA UNF - SAE

Ø	P	Ø Nominal mm
Nº 4	- 48 h	2,84
Nº 5	- 44 h	3,17
Nº 6	- 40 h	3,50
Nº 8	- 36 h	4,16
Nº 10	- 32 h	4,82
Nº 12	- 28 h	5,48
1/4	- 28 h	6,35
5/16	- 24 h	7,94
3/8	- 24 h	9,52
7/16	- 20 h	11,11
1/2	- 20 h	12,70
9/16	- 18 h	14,29
5/8	- 18 h	15,87
3/4	- 16 h	19,05
7/8	- 14 h	22,22
1"	- 12 h	25,40
1 1/8	- 12 h	28,57
1 1/4	- 12 h	31,75
1 1/2	- 12 h	38,10



DATOS TÉCNICOS / DONNÉES TECHNIQUES / TECHNICAL DATA / DATI TECNICI / DADOS TÉCNICOS

PULGADAS	P	
1/64"	0,015625"	0,397
1/32"	0,03125"	0,794
3/64"	0,046875"	1,191
1/16"	0,0625"	1,588
5/64"	0,078125"	1,984
3/32"	0,09375"	2,381
7/64"	0,109375"	2,778
1/8"	0,125"	3,175
9/64"	0,140625"	3,572
5/32"	0,15625"	3,969
11/64"	0,171875"	4,366
3/16"	0,1875"	4,762
13/64"	0,203125"	5,159
7/32"	0,21875"	5,556
15/64"	0,234375"	5,953
1/4"	0,25"	6,35
17/64"	0,265625"	6,747
9/32"	0,28125"	7,144
19/64"	0,296875"	7,541
5/16"	0,3125"	7,938
21/64"	0,328125"	8,334
11/32"	0,34375"	8,731
23/64"	0,359375"	9,128
3/8"	0,375"	9,525
25/64"	0,390625"	9,922
14/32"	0,40625"	10,319
27/64"	0,421875"	10,716
7/16"	0,4375"	11,112
29/60"	0,453125"	11,509
15/32"	0,46875"	11,906
31/64"	0,484375"	12,303
1/2"	0,5"	12,7
33/64"	0,515625"	13,097
17/32"	0,53125"	13,494
35/64"	0,546875"	13,891
9/16"	0,5625"	14,288
37/64"	0,578125"	14,684
19/32"	0,59375"	15,081
39/64"	0,609375"	15,478
5/8"	0,625"	15,875
41/64"	0,640625"	16,272
21/32"	0,65625"	16,669
43/64"	0,671875"	17,066
11/16"	0,6875"	17,462
45/64"	0,703125"	17,859
23/32"	0,71875"	18,256
47/64"	0,734375"	18,653
3/4"	0,75"	19,05
49/64"	0,765625"	19,447
25/32"	0,78125"	19,844
51/64"	0,796875"	20,241
13/16"	0,8125"	20,638
53/64"	0,828125"	21,034
27/32"	0,84375"	21,431
55/64"	0,859375"	21,828
7/8"	0,875"	22,225
57/64"	0,890625"	22,622
29/32"	0,90625"	23,019
59/64"	0,921875"	23,416
15/16"	0,9375"	23,812
61/64"	0,953125"	24,209
31/32"	0,96875"	24,606
63/64"	0,984375"	25,003

Tabla de conversión: pulgadas-mm / Tableaux de conversion: pouces - mm / Conversion tables: inch - mm / Tavole di conversione: pollici - mm / Tabelas de conversão: polegadas - mm

DIN 912

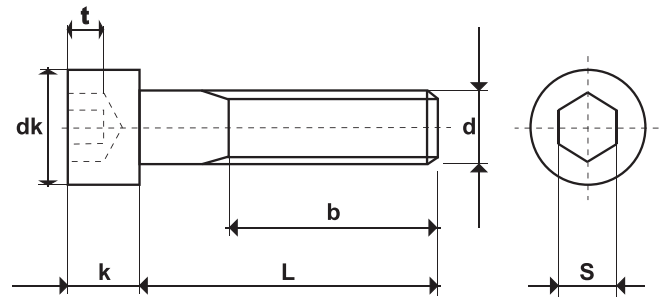

DIN 912

d	M5	M6	M8	M10	M12	M14	M16	M20
p	0,8	1	1,25	1,5	1,75	2	2	2,5
b	22	24	28	32	36	40	44	52
dk	8,5	10	13	16	18	21	24	30
k	5	6	8	10	12	14	16	20
S	4	5	6	8	10	12	14	17
t	2,5	3	4	5	6	7	8	10

DIN 931

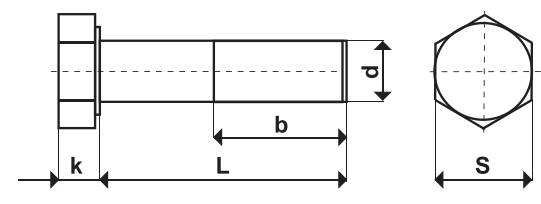

DIN 931

d	M3	M4	M5	M6	M7	M8	M10	M12	M14	M16	M18	M20	M22	M24	M27	M30	M33	M36
P Paso	0,5	0,7	0,8	1	1	1,25	1,5	1,75	2	2	2,5	2,5	2,5	3	3	3,5	3,5	4
S	5,5	7	8	10	11	13	16	18	21	24	27	30	34	36	41	46	50	55
K nom.	2	2,8	3,5	4	5	5,3	6,4	7,5	8,8	10	11,5	12,5	14	15	17	18,7	21	22,5
b<125 mm	12	14	16	18	20	22	26	30	34	38	42	46	50	54	60	66	72	78
200 mm > b					20	28	32	36	40	44	48	52	56	60	66	72	78	84
> 125 mm																		
b>200 mm										57	61	65	69	73	79	85	91	97

DIN 7991

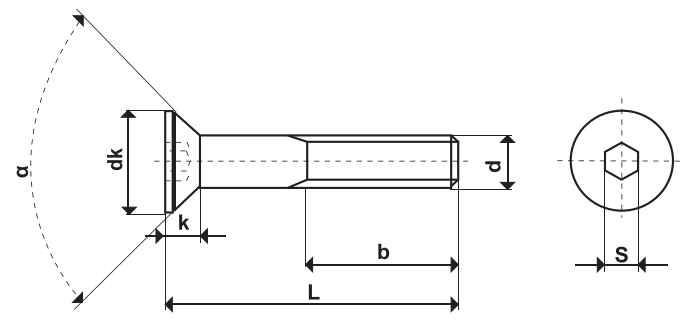

DIN 912

d	M3	M4	M5	M6	M8	M10	M12	M14	M16	M20	M22	M24
p	0,5	0,7	0,8	1	1,25	1,5	1,75	2	2	2,5	2,5	3
b	12	14	16	18	22	26	30	34	38	46	50	54
dk	6	8	10	12	16	20	24	27	30	36	36	39
k	1,7	2,3	2,8	3,3	4,4	5,5	6,5	7	7,5	8,5	13,1	14
S	2	2,5	3	4	5	6	8	10	10	12	14	14
alpha	90°											60°



	ES	FR	EN	IT	PT
Ref	Referencia	Référence	Reference	Riferimento	Referência
	Precio	Prix	Price	Prezzo	Preço
	Longitud	Longueur	Length	Lunghezza	Comprimento
	Packing	Conditionnement	Packing	Imballo	Embalagem
	Rosca	Filetage	Thread	Rivettatura	Rosca entrada de ar PT
	Medidas	Mesures	Measurements	Misure	Medidas
	Número de dientes, Dientes	Nombre de dents, dents	Number of teeth, Teeth	N° denti	Número de dentes, Dentes
	Arandela	Rondelle	Washer	Rondella	Arruela
	Medida interior	Dimension interieure	Inside measure	Misura interna	Medida interior
	Medida exterior, Diámetro arandela	Dimension extérieure, Diametre de rondelle	Dimension extérieure, Diametre de rondelle	Misura esterna, Diametro rondella	Medida exterior, Diâmetro da arruela
	Tipo de cabeza	Type de tete	Head type	Tipo di testa	Tipo de cabeça
	Huella Torx	Empreinte Torx	Torx tip	Testa Torx	Ponta de Torx
P	Paso	Pas metrique	Thread	Passo	Passo
M	Métrica	Métrique	Metric	Metrico	Métrica
	Rosca métrica	Filetage métrique	Metric thread	Filettatura metrica	Rosca métrica
	Descripción	Description	Description	Descrizione	Descrição
	Contenido, kit, incluye	Contenu, Kit ou incluant	Contains, Kit or includes	Contenuto, kit	Inclui

cofan



TE AYUDAMOS A SER TODO UN PROFESIONAL



Notas / Notas

A series of 25 horizontal dotted lines for writing.

cofan
home



SACAMOS EL MÁXIMO PARTIDO A TU HOGAR

Notas / Notas

A series of horizontal dotted lines for writing notes.



www.cofan.es

VENTA EXCLUSIVA MAYORISTAS
VENTE EXCLUSIVEMENT AUX GROSSISTES
EXCLUSIVE SALE TO WHOLESALERS
VENDITA ESCLUSIVA GROSSISTI
VENDA EXCLUSIVE GROSSISTAS

COFAN, S.A.

Avenida de la Industria, S.N.
13610 Campo de Criptana / Ciudad Real / España
Tel.: +34 926 56 39 28
Email: cofan@cofansa.com / www.cofan.es

DISTRIBUIDOR / DISTRIBUTOR:

**"PARA PONER
LOGO PEFC"**

